



Product  
Catalogue  
2024



# Product Categories at a Glance



## Linear Lighting

- Strip Series
- 120V eStrip
- eStrip
- Neon Flex
- String Lights
- Wall Washer

## Under Cabinet Lighting

### Landscape Lighting

- Flood and Spot Lights
- Pathway Lights
- Wall and Deck Lights
- In Ground Lights
- Transformers and Accessories

### Down Lighting

- Thin Lines
- Regressed
- Gimbal
- Surface Mount / Decorative
- T-Edge Lights
- Fire Rated

## Industrial Lighting

## Drivers and Controllers

## Tokistar Lighting

Looking for something specific? Click the Magic Lite logo in the top right corner to access the [Appendix](#) for a detailed category breakdown and item locations.

# Why Magic Lite?



At Magic Lite, we've built a foundation of trust and innovation over the past 4 decades, dedicated to illuminating spaces with state-of-the-art lighting technology.

## Here's how we make a difference:

- Your needs first:** Our product catalog has grown over the years to better cater to your diverse lighting requirements, ensuring you always find what you need.
- Unmatched value:** We pride ourselves on offering competitive prices without compromising quality, providing exceptional value for your investment.
- Peace of mind:** Our products are backed by substantial warranty support, giving you a seamless and worry-free lighting experience.
- Custom displays:** With a variety of [POP display options](#), we make it easy for you to highlight your lighting selections effectively.

## Featured Logos/Symbols



Intertek's ETL Certified



Energy Star Certified



CCT



cULus Certified



Wet Location Listed



RGB



DLC Certified



Wattage Adjustable



Dimmable



120 Volts of AC Power





# Linear Lighting



# High Density, High Power Indoor



Ideal for display cabinets needing high illumination.  
Can be used as a wall grazer offering great vertical illumination.

## FEATURES

- 1 Bin
- 2 Step MacAdam Ellipse
- 3oz PCB board
- 3M Adhesive
- 50,000 hours life
- High brightness 3528 Epistar LEDs
- Field cuttable
- Low power consumption
- Available in 16' (5m) and 100' (30.48m) spools (custom cuts available)
- 16' spools come with 6Ft pre-soldered power feeds
- Safe, 24V class 2 power supplies (sold separately)
- Fully dimmable with dimmable power supplies (sold separately)
- 6 years limited warranty

## APPLICATIONS

- Aisle and stairway lighting
- Cabinet and cove lighting
- Back lighting
- Showcase lighting
- Linear decorative lighting

## SPECIFICATIONS

Product Code		LTP-XX-YY-HD-H90 (XX: Length in feet; YY: Colour temperature)
Electrical	Input Voltage	24V DC
	Power Consumption	5.8W/Ft
Specs	Colour Temperature	2700/3000/4000/6500K
	CRI	90+
	Lumen Output	450 Lumens per ft 3000K; 468 Lumens per ft 4000K; 514 Lumens per ft 6500K
	Efficacy	77 LPW 3000K; 80 LPW 4000K; 88 LPW 6500K
	Dimmable	Yes
LED	Beam Angle	120°
	Type	High Brightness 3528 Epistar LEDs
	Life Span	50,000 Hours
	Spacing	1" (25mm)
	# per foot (304mm)	72
Design	Dimensions (Inches)	.39" W
	Dimensions (Millimeters)	10mm W
	Max Single Run Length	16Ft
	Custom Cuttable	1" (25mm)
	Approved Location	Indoor
Warranty		6 years
Approvals		cETLus

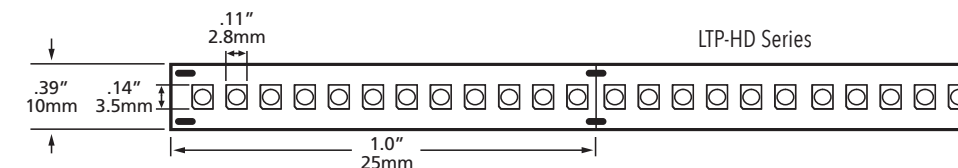

## PRODUCT CODES

XX: Length in feet; YY: Colour temperature

16Ft spools  
LTP - 16 - YY - HD - H90

100Ft spools  
LTP - 100 - YY - HD - H90

Custom cuts  
LTP - XX - YY - HD - H90

LED COLOUR  
2700K  
3000K  
4000K  
6500K

LED COLOUR  
2700K  
3000K  
4000K  
6500K

LED COLOUR  
2700K  
3000K  
4000K  
6500K

## ACCESSORIES



**LTP-001-HD-HP-6**  
72" Power feed connector for high density indoor



**LMSII-001**  
Terminal block and junction box for connection to additional lengths of power cable if needed



**VO-C10-8**  
Clear PVC mounting "U" channel



**LV-SPIR-1CH-LV**  
PIR Motion Sensor, 1 Channel, 24V DC  
NOTE: To be used with non dimmable drivers only

NOTE: See page 36-37 for the complete range of aluminum extrusions.

## INDOOR/OUTDOOR DIMMABLE DRIVERS

## NON DIMMABLE DRIVERS

### MLDRE-40-24-DM

Max recommended load 36W or 6' LED Strip, min 8W or 2' LED Strip  
6.77" x 2.67" x 1.26" (171 x 68 x 32mm)

### MLDRE-96-24-DM

Max recommended load 90W or 16' LED Strip, min 8W or 2' LED Strip  
6.77" x 2.67" x 1.26" (171 x 68 x 32mm)

### MLDR-120-24

Indoor/Outdoor driver  
Max. recommended load 90W or 16' (4.8m) per single tap, 120W or 20' (6.1m) combined two secondary taps.  
120W hardwire  
Input: 100 - 240V AC  
Output: 24V DC  
10" x 3 3/8" x 3 3/16" (254 x 85.7 x 80.9mm)

### MLDR-20-24JB

Indoor driver  
Max recommended load 18W or 3' LED Strip  
20W hardwire  
Input: 100 - 240V AC  
Output: 24V DC  
4 1/8" x 4 1/8" x 1 1/2" (104.8 x 104.8 x 38.1mm)



# High Density, Low Power Indoor



Suitable for display cabinets and applications needing lower but even illumination.

## FEATURES

- 1 Bin
- 2 Step MacAdam Ellipse
- 3oz PCB board
- 3M Adhesive
- 50,000 hours life
- High brightness 5060 SMD LEDs
- Field cuttable
- Low power consumption
- Available in 16' (5m) and 100' (30.48m) spools (custom cuts available)
- Safe, 24V class 2 power supplies (sold separately)
- Fully dimmable with dimmable power supplies (sold separately)
- 16' spools come with 6 ft. pre-soldered power feeds
- 6 year limited warranty

## APPLICATIONS

- Aisle and stairway lighting
- Cabinet and cove lighting
- Back lighting
- Showcase lighting
- Linear decorative lighting

## SPECIFICATIONS

Product Code		LTP-XX-YY-HD-LP-H90 (XX: Length in feet; YY: Colour temperature)
Electrical	Input Voltage	24V DC
	Power Consumption	2.9W/Ft
Specs	Colour Temperature	2700/3000/4000/6500K
	CRI	90+
	Lumen Output	225 Lumens per ft 3000K; 234 Lumens per ft 4000K; 257 Lumens per ft 6500K
	Efficacy	77 LPW 3000K; 80 LPW 4000K; 88 LPW 6500K
	Dimmable	Yes
	Beam Angle	120°
LED	Type	High Brightness 3528 Epistar LEDs
	Life Span	50,000 Hours
	Spacing	8.3mm
	# per foot (304mm)	36
Design	Dimensions (Inches)	31" W
	Dimensions (Millimeters)	0 8mm W
	Max Single Run Length	31Ft
	Custom Cuttable	2" (50mm)
	Approved Location	Indoor
Warranty		6 years
Approvals		cETLus

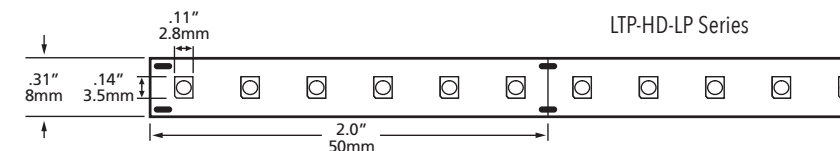

## PRODUCT CODES

XX: Length in feet; YY: Colour temperature

16Ft spools  
LTP - 16 - YY - HD - LP - H90

LED COLOUR  
2700K  
3000K  
4000K  
6500K

100Ft spools  
LTP - 100 - YY - HD - LP - H90

LED COLOUR  
2700K  
3000K  
4000K  
6500K

Custom cuts  
LTP - XX - YY - HD - LP - H90

LED COLOUR  
2700K  
3000K  
4000K  
6500K

## ACCESSORIES

## NON DIMMABLE DRIVERS

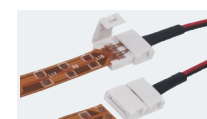

**LTP-001-HD-6**  
72" Power feed connector for high density indoor



**LTP-002-HD**  
In-line connector for high density indoor

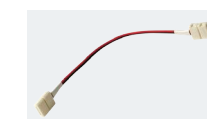

**LTP-STP-HD-6IN**  
6" In-line connector for high density indoor

### MLDR-120-24

Indoor/Outdoor driver  
Max. recommended load 90W or 31' (9.4m) per single tap, 120W or 41' (12.5m) combined two secondary taps.  
120W hardwire  
Input: 100 - 240V AC  
Output: 24V DC  
10" x 3 3/8" x 3 3/16" (254 x 85.7 x 80.9mm)



**LV-SPIR-1CH-LV**  
PIR Motion Sensor, 1 Channel, 24V DC  
NOTE: To be used with non dimmable drivers only



**LMSII-001**  
Terminal block and junction box for connection to additional lengths of power cable if needed



**VO-C10-8**  
Clear PVC mounting "U" channel

### MLDR-20-24JB

Indoor driver  
Max recommended load 18W or 6' LED Strip  
20W hardwire  
Input: 100 - 240V AC  
Output: 24V DC  
4 1/8" x 4 1/8" x 1 1/2" (104.8 x 104.8 x 38.1mm)

NOTE: See page 36-37 for the complete range of aluminum extrusions.

## INDOOR/OUTDOOR DIMMABLE DRIVERS

### MLDRE-40-24-DM

Max recommended load 36W or 6' LED Strip, min 8W or 2' LED Strip  
6.77" x 2.67" x 1.26" (171 x 68 x 32mm)

### MLDRE-96-24-DM

Max recommended load 90W or 31' LED Strip, min 8W or 3' LED Strip  
6.77" x 2.67" x 1.26" (171 x 68 x 32mm)



# CCT Indoor

Where applications demand a greater dynamic range within the White Light Spectrum. Hospitality, retail, residential and commercial.

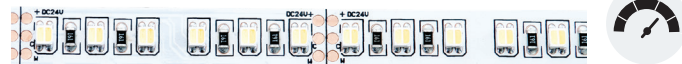

## FEATURES

- 50,000 hours life
- High brightness 3528 SMD LEDs
- Field cuttable
- Low power consumption
- Available in 16' (5M) spools
- 16' spools come with 6 ft. pre-soldered power feeds
- Safe, 24V class 2 power supplies (sold separately)
- Controller sold separately
- 6 year limited warranty

## APPLICATIONS

- Aisle and stairway lighting
- Cabinet and cove lighting
- Back lighting
- Showcase lighting
- Linear decorative lighting

## SPECIFICATIONS

<b>Product Code</b>		LTP-16-CCT-H90
<b>Electrical</b>	<b>Input Voltage</b>	24V DC
	<b>Power Consumption</b>	5.8W/Ft
<b>Specs</b>	<b>Colour Temperature</b>	2500K-7000K
	<b>CRI</b>	90+
	<b>Lumen Output</b>	261 Lumens per ft 3000K; 383 Lumens per ft 7000K
	<b>Efficacy</b>	77 LPW 3000K, 80 LPW 4000K, 88 LPW 6500K
	<b>Dimmable</b>	No
	<b>Beam Angle</b>	120°
<b>LED</b>	<b>Type</b>	High Brightness 3528 SMD LEDs
	<b>Life Span</b>	50,000 Hours
	<b>Spacing</b>	8.3mm
	<b># per foot (304mm)</b>	36
<b>Design</b>	<b>Dimensions (Inches)</b>	.39" W
	<b>Dimensions (Millimeters)</b>	10mm W
	<b>Max Single Run Length</b>	16Ft
	<b>Custom Cuttable</b>	2" (50mm)
	<b>Approved Location</b>	Indoor
<b>Warranty</b>	6 years	
<b>Approvals</b>	cETLus	

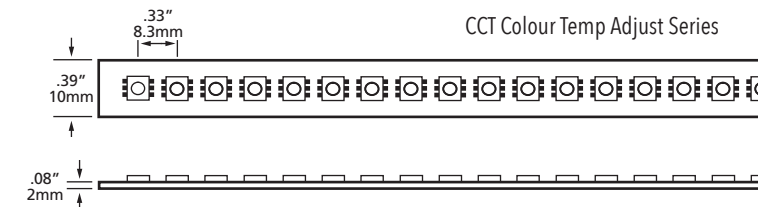

## PRODUCT CODES

16Ft spools  
LTP - 16 - CCT - H90

## ACCESSORIES

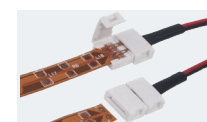

**LTP-001-CCT-6**  
72" Power feed connector for CCT indoor. Add "-O" for opposite end.



**LTP-002-CCT**  
In-line connector for CCT series indoor

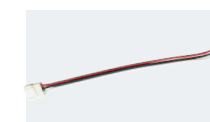

**LTP-STP-CCT-6IN**  
6" (15cm) in-line connector for CCT Adjust



**VO-C10-8**  
Clear PVC mounting "U" channel



**LT-WIFI-AMP**  
WiFi Signal Amplifier for RGB, RGBW, CCT



**LT-WIFI-CTRL**  
3 IN 1 LED Strip Controller (WiFi+2.4G)



**LT-WIFI-RM**  
4-Zone RGB+CCT Remote

**NOTE:** See page 36-37 for the complete range of aluminum extrusions.

## NON DIMMABLE DRIVERS

**MLDR-120-24**  
Indoor/Outdoor driver  
Max 21.4' (6.5m) per single tap  
Max 28' (8.5m) combined 2 secondary taps  
Input: 100 - 240V AC  
Output: 24V DC  
10" x 3 3/8" x 3 3/16" (254 x 85.7 x 80.9mm)

**MLDR-20-24JB**  
Indoor driver  
Max recommended load 18W 4.3' (1.3m)  
Input: 100 - 240V AC  
Output: 24V DC  
20 Watts  
4 1/8" x 4 1/8" x 1 1/2" (104.8 x 104.8 x 38.1mm)





# COB Indoor

The COB indoor lights are designed for optimal performance, delivering uniform lighting ideal for a variety of settings including commercial spaces, retail environments, and homes.

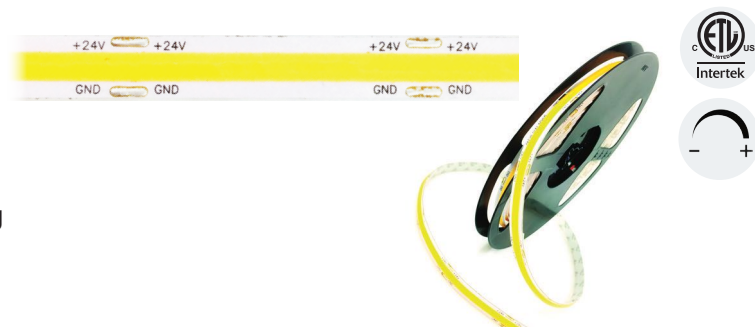

## FEATURES

- 1 Bin
- 2 Step MacAdam Ellipse
- 3oz PCB board
- 3M Adhesive
- Field cuttable every 50mm (2")
- Low power consumption
- Smooth luminance - no hot spots
- Available in 20' (6.1m) and 100' (30.48m) spools (custom cuts available)
- 20' spools come with 6Ft pre-soldered power feeds
- Safe, 24V DC operation
- Fully dimmable with dimmable power supplies (sold separately)
- 6 years limited warranty

## APPLICATIONS

- Aisle and stairway lighting
- Cabinet and cove lighting
- Back lighting
- Showcase lighting
- Linear decorative lighting

SPECIFICATIONS		
<b>Product Code</b>	LTP-XX-YY-COB-H90 and LTP-XX-YY-COB (XX: Length in feet; YY: Colour temperature)	
<b>Electrical</b>	Input Voltage	24V DC
	Power Consumption	4.2W/Ft
<b>Specs</b>	Colour Temperature	2700/3000/3500/4000/6500K
	CRI	90+ for white colour temperatures
	Lumen Output	315 Lumens per ft 2700K; 319 Lumens per ft 3000K; 328 Lumens per ft 3500K; 336 Lumens per ft 4000K; 374 Lumens per ft 6500K
	Efficacy	75 LPW 2700K; 76 LPW 3000K; 78 LPW 3500K; 80 LPW 4000K; 89 PLW 6500K
	Dimmable	Yes
	Beam Angle	120°
<b>LED</b>	Type	Chip on Board
	Life Span	50,000 Hours
	Spacing	2mm
	# per foot (304mm)	91
<b>Design</b>	Dimensions (Inches)	.39" W
	Dimensions (Millimeters)	10mm W
	Max Single Run Length	20Ft
	Custom Cuttable	2" (50mm)
	Approved Location	Indoor
<b>Warranty</b>	6 years	
<b>Approvals</b>	cETLus	

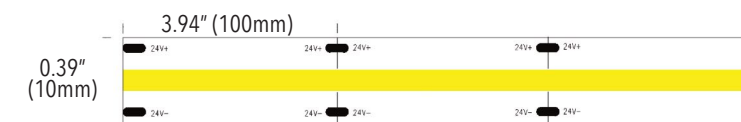

## PRODUCT CODES

XX: Length in feet; YY: Colour temperature



## ACCESSORIES



**LTP-001-HD-HP-6**  
72" Power feed connector for high density indoor



**LMSII-001**  
Terminal block and junction box for connection to additional lengths of power cable if needed



**VO-C10-8**  
Clear PVC mounting "U" channel



**LV-SPIR-1CH-LV**  
PIR Motion Sensor, 1 Channel, 24V DC  
NOTE: To be used with non dimmable drivers only

NOTE: See page 36-37 for the complete range of aluminum extrusions.

## INDOOR/OUTDOOR DIMMABLE DRIVERS

## NON DIMMABLE DRIVERS

**MLDRE-40-24-DM**  
Max 8.6' (2.6m)  
Min 8 Watts, 1.9'(0.57M) LED COB Strip  
6.77" x 2.67" x 1.26" (171 x 68 x 32mm)

**MLDRE-96-24-DM**  
Max 21.4' (6.5m)  
Min 8 Watts, 1.9'(0.57m) LED COB Strip  
6.77" x 2.67" x 1.26" (171 x 68 x 32mm)

**MLDR-120-24**  
Indoor/Outdoor driver  
Max 21.4' (6.5m) per single tap  
Max 28' (8.5m) combined 2 secondary taps  
Input: 100 - 240V AC  
Output: 24V DC  
10" x 3 3/8" x 3 3/16" (254 x 85.7 x 80.9mm)

**MLDR-20-24JB**  
Indoor driver  
Max recommended load 18W 4.3' (1.3m)  
Input: 100 - 240V AC  
Output: 24V DC  
20 Watts  
4 1/8" x 4 1/8" x 1 1/2" (104.8 x 104.8 x 38.1mm)



# Dim to Warm

Suitable for both hospitality and residential applications creating an inviting atmosphere.



## FEATURES

- 1 Bin
- 2 Step MacAdam Ellipse
- 3oz PCB board
- 3M Adhesive
- 50,000 hours life
- Field cuttable every 50mm (2")
- Low power consumption
- Auto Warm-dim technology
- Available in 16' (5m) and 100' (30.48m) spools (custom cuts available)
- 16' spools come with 6Ft pre-soldered power feeds
- Safe, 24V DC operation
- Dim-to-warm: 1800k to 3000K
- No special controllers required
- 6 years limited warranty

## APPLICATIONS

- Aisle and stairway lighting
- Cabinet and cove lighting
- Back lighting
- Showcase lighting
- Linear decorative lighting

## SPECIFICATIONS

<b>Product Code</b>		LTP-XX-WW-DIM-H90 (XX: Length in feet; WW: Warm white)
<b>Electrical</b>	Input Voltage	24V DC
	Power Consumption	5.5W/Ft
<b>Specs</b>	Colour Temperature	1800-3000K
	CRI	90+
	Lumen Output	449LM/Ft
	Efficacy	82 LPW
	Dimmable	Yes
	Beam Angle	120°
<b>LED</b>	Type	2835 LEDs
	Life Span	50,000 Hours
	Spacing	2mm
	# per foot (304mm)	240
<b>Design</b>	Dimensions (Inches)	.39" W
	Dimensions (Millimeters)	10mm W
	Max Single Run Length	16Ft
	Custom Cuttable	2" (50mm)
	Approved Location	Indoor
<b>Warranty</b>		6 years
<b>Approvals</b>		cETLus

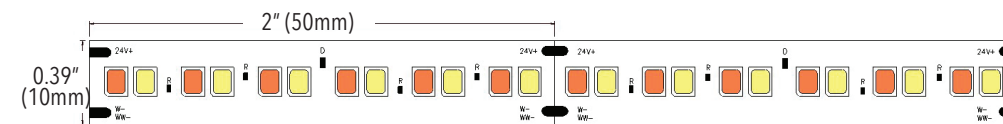

## PRODUCT CODES

XX: Length in feet; WW: Warm white

### 16Ft spools

LTP - 16 - WW - DIM - H90

### 100Ft spools

LTP - 100 - WW - DIM - H90

### Custom cuts

LTP - XX - WW - DIM - H90

## ACCESSORIES

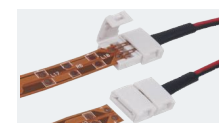

### LTP-001-HD-HP-6

72" Power feed connector for high density indoor



### LMSII-001

Terminal block and junction box for connection to additional lengths of power cable if needed



### VO-C10-8

Clear PVC mounting "U" channel

NOTE: See page 36-37 for the complete range of aluminum extrusions.

## INDOOR/OUTDOOR DIMMABLE DRIVERS

### MLDRE-40-24-DM

Max 6.5' (1.98m)  
Min 8 Watts, 1.45' (0.44m)  
6.77" x 2.67" x 1.26" (171 x 68 x 32mm)

### MLDRE-96-24-DM

Max 16' (5m)  
Min 8 Watts, 1.45' (0.44m)  
6.77" x 2.67" x 1.26" (171 x 68 x 32mm)



# High Efficacy Indoor

One of the highest lumen output solutions, for those applications needing high illumination and great colour rendering.

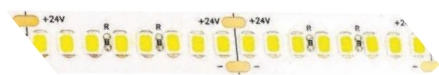

## FEATURES

- 1 Bin
- 2 Step MacAdam Ellipse
- 3oz PCB board
- 3M Adhesive
- 50,000 hours life
- Field cuttable every 1.3"
- Low power consumption
- Available in 16' (5m) and 100' (30.48m) spools (custom cuts available)
- 16' spools come with 6Ft pre-soldered power feeds
- Safe, 24V DC operation
- Fully dimmable with dimmable power supplies (sold separately)
- 6 years limited warranty

## APPLICATIONS

- Aisle and stairway lighting
- Cabinet and cove lighting
- Back lighting
- Showcase lighting
- Linear decorative lighting

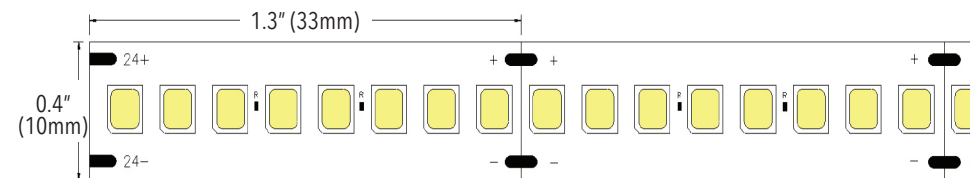

## PRODUCT CODES

XX: Length in feet; YY: Colour temperature

16Ft spools  
LTP - 16 - YY - HE - H90

- LED Strip Series High Efficacy, Indoor
- LED COLOUR: 2700K, 3000K, 3500K, 4000K, 6500K

100Ft spools  
LTP - 100 - YY - HE - H90

- LED Strip Series High Efficacy, Indoor
- LED COLOUR: 2700K, 3000K, 3500K, 4000K, 6500K

Custom Cut  
LTP - XX - YY - HE - H90

- LED Strip Series High Efficacy, Indoor
- LED COLOUR: 2700K, 3000K, 3500K, 4000K, 6500K

## SPECIFICATIONS

<b>Product Code</b>		LTP-XX-YY-HE-H90 (XX: Length in feet; YY: Colour temperature)
<b>Electrical</b>	Input Voltage	24V DC
	Power Consumption	5.1W/Ft
<b>Specs</b>	Colour Temperature	2700/3000/3500/4000/6500K
	CRI	90+
	Lumen Output	508 Lumens per ft 2700K; 512 Lumens per ft 3000K; 527 Lumens per ft 3500K; 540 Lumens per ft 4000K; 586 Lumens per ft 6500K
	Efficacy	100 LPW 2700K; 100 LPW 3000K; 103 LPW 3500K; 106 LPW 4000K; 115 LPW 6500K
	Dimmable	Yes
	Beam Angle	120°
<b>LED</b>	Type	High Brightness 2835 LEDs
	Life Span	50,000 Hours
	Spacing	4mm
	# per foot (304mm)	73
<b>Design</b>	Dimensions (Inches)	.4" W
	Dimensions (Millimeters)	10mm W
	Max Single Run Length	16Ft
	Custom Cuttable	1.3" (33mm)
	Approved Location	Indoor
<b>Warranty</b>		6 years
<b>Approvals</b>		cETLus

## ACCESSORIES



**LTP-001-HD-HP-6**  
72" Power feed connector for high density indoor



**LMSII-001**  
Terminal block and junction box for connection to additional lengths of power cable if needed



**VO-C10-8**  
Clear PVC mounting "U" channel



**LV-SPIR-1CH-LV**  
PIR Motion Sensor, 1 Channel, 24V DC  
NOTE: To be used with non dimmable drivers only

NOTE: See page 36-37 for the complete range of aluminum extrusions.

## INDOOR/OUTDOOR DIMMABLE DRIVERS

**MLDRE-40-24-DM**  
Max 7' (2.1m)  
Min 8 Watts, 1.5'(0.45M) LED High Efficacy Strip  
6.77" x 2.67" x 1.26" (171 x 68 x 32mm)

**MLDRE-96-24-DM**  
Max 17.6' (5.3m)  
Min 8 Watts, 1.5'(0.45m) LED High Efficacy Strip  
6.77" x 2.67" x 1.26" (171 x 68 x 32mm)

## NON DIMMABLE DRIVERS

**MLDR-120-24**  
Indoor/Outdoor driver  
Max 17.6 (5.3m) per single tap  
Max 23' (7m) combined 2 secondary taps  
Input: 100 - 240V AC  
Output: 24V DC  
10" x 3 3/8" x 3 3/16" (254 x 85.7 x 80.9mm)

**MLDR-20-24JB**  
Indoor driver  
Max recommended load 18W 3.6'(1.1m) LED High Efficacy Strip  
Input: 100 - 240V AC  
Output: 24V DC  
20 Watts  
4 1/8" x 4 1/8" x 1 1/2" (104.8 x 104.8 x 38.1mm)

# High Power Indoor

Suitable for high ceiling coves or areas that require higher illumination. Commercial, retail, hospitality and residential applications.



## FEATURES

- 1 Bin
- 2 Step MacAdam Ellipse
- 3oz PCB board
- 3M Adhesive
- 50,000 hours life
- High brightness 5060 SMD LEDs
- Field cuttable
- Low power consumption
- Available in 20' (6.1m) and 100' (30.48m) spools (custom cuts available)
- Safe, 24V class 2 power supplies (sold separately)
- Fully dimmable with dimmable power supplies (sold separately)
- 20' spools come with 6 ft. pre-soldered power feeds
- 6 years limited warranty

## APPLICATIONS

- Aisle and stairway lighting
- Cabinet and cove lighting
- Back lighting
- Showcase lighting
- Linear decorative lighting

## SPECIFICATIONS

<b>Product Code</b>		LTP-XX-YY-H90 and LTP-XX-YY (XX: Length in feet; YY: Colour temperature)
<b>Electrical</b>	Input Voltage	24V DC
	Power Consumption	4.3W/Ft
<b>Specs</b>	Colour Temperature	2700/3000/3500/4000/6500K
	CRI	90+ [Note: For LTP-XX-YY series, the CRI is 80]
	Lumen Output	280 Lumens per ft 2700K; 285 Lumens per ft 3000K; 293 Lumens per ft 3500K; 300 Lumens per ft 4000K; 325 Lumens per ft 6500K
	Efficacy	65 LPW 2700K; 66 LPW 3000K; 68 LPW 3500K; 70 LPW 4000K; 75 LPW 6500K
	Dimmable	Yes
	Beam Angle	120°
<b>LED</b>	Type	High Brightness 5060 SMD LEDs
	Life Span	50,000 Hours
	Spacing	16mm
	# per foot (304mm)	18
<b>Design</b>	Dimensions (Inches)	.39" W
	Dimensions (Millimeters)	10mm W
	Max Single Run Length	20Ft
	Custom Cuttable	1.3" (33mm)
	Approved Location	Indoor
<b>Warranty</b>		6 years
<b>Approvals</b>		cETLus

## PRODUCT CODES

XX: Length in feet; YY: Colour temperature

20Ft spools  
LTP - 20 - YY - H90

**LED COLOUR**  
2700K  
3000K  
3500K  
4000K  
6500K

100Ft spools  
LTP - 100 - YY - H90

**LED COLOUR**  
2700K  
3000K  
3500K  
4000K  
6500K

Custom cuts  
LTP - XX - YY - H90

**LED COLOUR**  
2700K  
3000K  
3500K  
4000K  
6500K

LTP - 20 - YY

**LED COLOUR**  
RD: Red  
AM: Amber  
GR: Green  
BL: Blue

LTP - 100 - YY

**LED COLOUR**  
RD: Red  
AM: Amber  
GR: Green  
BL: Blue

LTP - XX - YY

**LED COLOUR**  
RD: Red  
AM: Amber  
GR: Green  
BL: Blue

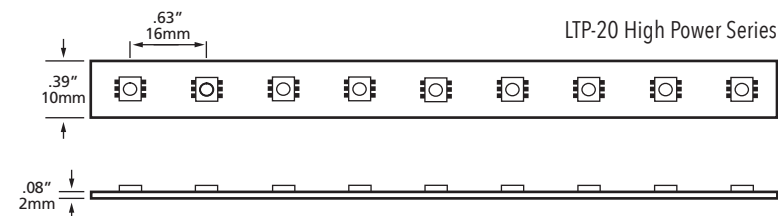

## DIMMABLE DRIVERS

### MLDRE-40-24-DM

Max recommended load 36W or 8' LED Strip,  
min 8W or 2' LED Strip  
6.77" x 2.67" x 1.26" (171 x 68 x 32mm)

### MLDRE-96-24-DM

Max recommended load 90W or 20' LED Strip,  
min 8W or 2' LED Strip  
6.77" x 2.67" x 1.26" (171 x 68 x 32mm)

## NON-DIMMABLE DRIVERS

### MLDR-120-24

Indoor/Outdoor driver  
Max. recommended load 90W or 20' (6.1m) per single tap,  
120W or 27' (8.23m) combined two secondary taps.  
120W hardwire  
Input: 100 - 240V AC  
Output: 24V DC  
10" x 3 3/8" x 3 3/16" (254 x 85.7 x 80.9mm)

### MLDR-20-24JB

Indoor driver  
Max recommended load 18W or 4' LED Strip  
20W hardwire  
Input: 100 - 240V AC  
Output: 24V DC  
4 1/8" x 4 1/8" x 1 1/2" (104.8 x 104.8 x 38.1mm)

## ACCESSORIES

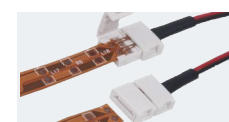

**LTP-001-6R**  
72" Power feed connector for single colour indoor. Add "-L" to code for opposite end, add "-CM" for through wall connections.



**LTP-002**  
In-line connector for CCT series indoor



**VO-C10-8**  
Clear PVC mounting "U" channel



**LTP-001-12R**  
12' (144") Power feed connector for single colour indoor



**LTP-STP-6IN**  
5.9" (15cm)  
**LTP-STP-21IN**  
21" (53cm)



**LMSII-001**  
Terminal block and junction box for connection to additional lengths of power cable if needed



**LTP-003-6DC**  
DC connector for LED strip series with 6" wire and DC connector

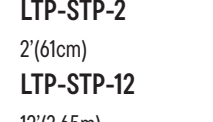

**LTP-STP-2**  
2' (61cm)  
**LTP-STP-12**  
12' (3.65m)  
In-line connector for single colour indoor



**LV-SPIR-1CH-LV**  
PIR Motion Sensor, 1 Channel, 24V DC  
NOTE: To be used with non dimmable drivers only

**NOTE:** See page 36-37 for the complete range of aluminum extrusions.



# High Power Outdoor

Exterior rated suitable for those commercial, retail and hospitality applications requiring higher illumination.



## FEATURES

- 1 Bin
- 2 Step MacAdam Ellipse
- 3oz PCB board
- 3M Adhesive
- 50,000 hours life
- High brightness 5060 SMD LEDs
- Field cuttable

- Low power consumption
- Available in 20' (6.1m) spools
- Safe, 24V class 2 power supplies (sold separately)
- Fully dimmable with dimmable power supplies (sold separately)
- 6 years limited warranty

## APPLICATIONS

- Aisle and stairway lighting
- Cabinet and cove lighting
- Back lighting
- Showcase lighting
- Linear decorative lighting

## SPECIFICATIONS

<b>Product Code</b>		LTP-OD-20-YY-H90 (YY: Colour temperature)
<b>Electrical</b>	<b>Input Voltage</b>	24V DC
	<b>Power Consumption</b>	4.3W/Ft
<b>Specs</b>	<b>Colour Temperature</b>	2700/3000/3500/4000/6500K
	<b>CRI</b>	90+
	<b>Lumen Output</b>	280 Lumens per ft 2700K; 285 Lumens per ft 3000K; 293 Lumens per ft 3500K; 300 Lumens per ft 4000K; 325 Lumens per ft 6500K
	<b>Efficacy</b>	65 LPW 2700K; 66 LPW 3000K; 68 LPW 3500K; 70 LPW 4000K; 75 LPW 6500K
	<b>Dimmable</b>	Yes
	<b>Beam Angle</b>	120°
<b>LED</b>	<b>Type</b>	High Brightness 5060 SMD LEDs
	<b>Life Span</b>	50,000 Hours
	<b>Spacing</b>	16mm
	<b># per foot (304mm)</b>	18
<b>Design</b>	<b>Dimensions (Inches)</b>	.39" W
	<b>Dimensions (Millimeters)</b>	10mm W
	<b>Max Single Run Length</b>	20Ft
	<b>Custom Cuttable</b>	4"
	<b>Approved Location</b>	Outdoor
<b>Warranty</b>		6 years
<b>Approvals</b>		cETLus

NOTE: Outdoor Strip Series comes with liquid-tight connectors pre-installed on both ends, so it is necessary to make the cuts starting from extremities. Cut pieces can be terminated, but not joined together.

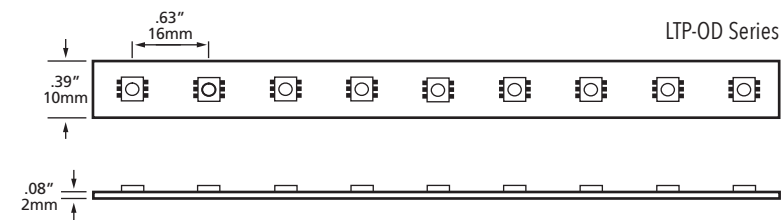

## PRODUCT CODES

YY: Colour temperature

LTP - OD - 20 - YY - H90

- LED COLOUR**  
 2700K  
 3000K  
 3500K  
 4000K  
 6500K

## ACCESSORIES



**LTP-001-OD-6FT**  
72" Power feed connector for single colour outdoor



**LV-FS-MC-004**  
Mounting clips



**LV-FS-EC-001**  
End caps



**VO-C10-8**  
Clear PVC mounting "U" channel

NOTE: See page 36-37 for the complete range of aluminum extrusions.

## INDOOR/OUTDOOR DIMMABLE DRIVERS

## NON DIMMABLE DRIVERS

### MLDRE-40-24-DM

Max 7' (2.1m)  
Min 8 Watts, 1.5'(0.45M) LED High Efficacy Strip  
6.77" x 2.67" x 1.26" (171 x 68 x 32mm)

### MLDRE-96-24-DM

Max recommended load 90W or 16' LED Strip,  
min 8W or 2' LED Strip  
6.77" x 2.67" x 1.26" (171 x 68 x 32mm)

NOTE: For outdoor installations, please add E-KO-SR strain relief (2pcs/driver).

### MLDR-120-24

Indoor/Outdoor driver  
Max 17.6 (5.3m) per single tap  
Max 23' (7m) combined 2 secondary taps  
Input: 100 - 240V AC  
Output: 24V DC  
10" x 3 3/8" x 3 3/16" (254 x 85.7 x 80.9mm)

# High Power, RGB Indoor

Excellent choice for dynamic environments such as cinemas, retail and hospitality needing higher illumination.

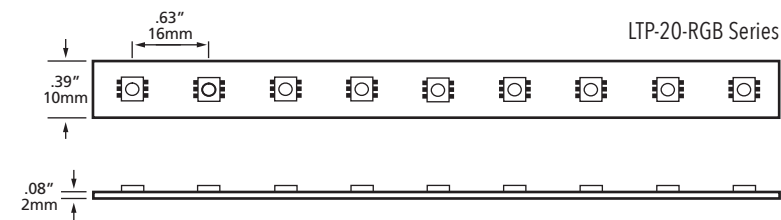

## FEATURES

- 50,000 hours life
- High brightness 5060 SMD LEDs
- Field cuttable
- Low power consumption
- Available in 20' (6.1m) and 100' (30.48m) spools (custom cuts available)
- 20' spools come with 6 ft. pre-soldered power feeds
- Safe, 24V class 2 power supplies (sold separately)
- Controllers sold separately
- 6 years limited warranty

## APPLICATIONS

- Aisle and stairway lighting
- Cabinet and cove lighting
- Back lighting
- Showcase lighting
- Linear decorative lighting

## SPECIFICATIONS

<b>Product Code</b>		LTP-XX-RGB (XX: Length in feet)
<b>Electrical</b>	Input Voltage	24V DC
	Power Consumption	4.3W/Ft
<b>Specs</b>	Colour Temperature	RGB
	CRI	80+
	Dimmable	Yes
	Beam Angle	120°
<b>LED</b>	Type	High Brightness 5060 SMD LEDs
	Life Span	50,000 Hours
	Spacing	16mm
	# per foot (304mm)	18
<b>Design</b>	Dimensions (Inches)	.39" W
	Dimensions (Millimeters)	10mm W
	Max Single Run Length	20Ft
	Custom Cuttable	4"
	Approved Location	Indoor
<b>Warranty</b>	6 years	
<b>Approvals</b>	cETLus	

## PRODUCT CODES

XX: Length in feet; YY: Colour temperature

20Ft spools  
LTP - 20 - RGB

100Ft spools  
LTP - 100 - RGB

Custom cuts  
LTP - XX - RGB

## ACCESSORIES



**LTP-001-RGB-6R**  
72" Power feed connector for RGB indoor. Add "-L" for opposite end.



**LTP-002-RGB**  
In-line connector for RGB indoor



**VO-C10-8**  
Clear PVC mounting "U" channel



**LTP-001-RGB-6IN**  
6" In-line connector for RGB indoor



**LT-WIFI-RM**  
4-Zone RGB+CCT Remote



**LT-WIFI-CTRL**  
3 IN 1 LED Strip Controller (WiFi+2.4G)



**LT-WIFI-AMP**  
WiFi Signal Amplifier for RGB, RGBW, CCT

**LTP-001-RGB-2IN**  
2" In-line connector for RGB indoor

**NOTE:** See page 36-37 for the complete range of aluminum extrusions.

## NON-DIMMABLE DRIVERS

**MLDR-120-24**  
Indoor/Outdoor driver  
Max. recommended load 90W or 20' (6.1m) per single tap, 120W or 27' (8.23m) combined two secondary taps.  
120W hardwire  
Input: 100 - 240V AC  
Output: 24V DC  
10" x 3 3/8" x 3 3/16" (254 x 85.7 x 80.9mm)

**MLDR-20-24JB**  
Indoor driver  
Max recommended load 18W or 4' LED Strip  
20W hardwire  
Input: 100 - 240V AC  
Output: 24V DC  
4 1/8" x 4 1/8" x 1 1/2" (104.8 x 104.8 x 38.1mm)



# High Power, RGB Outdoor

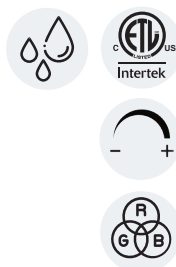

Great for enhancing outdoor spaces with a dynamic look. Suitable for hospitality, retail and commercial environments.

## FEATURES

- 50,000 hours life
- High brightness 5060 SMD LEDs
- Field cuttable
- Low power consumption
- Available in 20' (6.1m) spools
- Safe, 24V class 2 power supplies (sold separately)
- 6 years limited warranty

## APPLICATIONS

- Aisle and stairway lighting
- Cabinet and cove lighting
- Back lighting
- Showcase lighting
- Linear decorative lighting

## SPECIFICATIONS

<b>Product Code</b>	LTP-OD-20-RGB	
<b>Electrical</b>	Input Voltage	24V DC
	Power Consumption	4.3W/Ft
<b>Specs</b>	Colour Temperature	RGB
	CRI	80+
	Dimmable	Yes
	Beam Angle	120°
<b>LED</b>	Type	High Brightness 5060 SMD LEDs
	Life Span	50,000 Hours
	Spacing	16mm
	# per foot (304mm)	18
<b>Design</b>	Dimensions (Inches)	.39" W
	Dimensions (Millimeters)	10mm W
	Max Single Run Length	20Ft
	Custom Cuttable	4"
	Approved Location	Outdoor
<b>Warranty</b>	6 years	
<b>Approvals</b>	cETLus	

NOTE: Outdoor Strip Series comes with liquid-tight connectors pre-installed on both ends, so it is necessary to make the cuts starting from extremities. Cut pieces can be terminated, but not joined together.

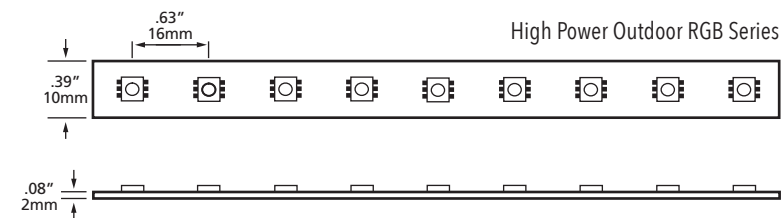

## PRODUCT CODES

20Ft spools  
LTP - OD - 20 - RGB

## ACCESSORIES



**LTP-RGB-001-OD-6FT**  
72" Power feed connector for RGB outdoor



**LV-FS-MC-004**  
Mounting clips



**LV-FS-EC-001**  
End caps



**VO-C10-8**  
Clear PVC mounting "U" channel



**LT-WIFI-RM**  
4-Zone RGB+CCT Remote



**LT-WIFI-CTRL**  
3 IN 1 LED Strip Controller (WiFi+2.4G)



**LT-WIFI-AMP**  
WiFi Signal Amplifier for RGB, RGBW, CCT

NOTE: See page 36-37 for the complete range of aluminum extrusions.

## NON-DIMMABLE DRIVERS

### MLDR-120-24

Indoor/Outdoor driver  
Max. recommended load 90W or 40' (12.1m) per single tap, 120W or 54' (16.46m) combined two secondary taps.  
120W hardwire  
Input: 100 - 240V AC  
Output: 24V DC  
10" x 3 3/8" x 3 3/16" (254 x 85.7 x 80.9mm)

# High Power, RGBW Indoor



Offers dynamic range of colour and dedicated white for greater versatility suitable for all market segments.

## FEATURES

- 50,000 hours life
- High brightness 5050 SMD LEDs
- Field cuttable
- Low power consumption
- Available in 20' (6.1m) and 100' (30.48m) spools (customcuts available)
- RGB colour change plus 3000K, 4000K and 6500K colour temperatures
- 20' spools come with 6 ft. pre-soldered power feeds
- Safe, 24V class 2 power supplies (sold separately)

## APPLICATIONS

- Aisle and stairway lighting
- Cabinet and cove lighting
- Back lighting
- Showcase lighting
- Linear decorative lighting

## SPECIFICATIONS

<b>Product Code</b>		LTP-XX-RGBYY-H90 (XX: Length in feet; YY: Colour temperature)
<b>Electrical</b>	Input Voltage	24V DC
	Power Consumption	4.3W/Ft
<b>Specs</b>	Colour Temperature	RGBW
	CRI	90+
	Beam Angle	120°
<b>LED</b>	Type	High Brightness 5050 SMD LEDs
	Life Span	50,000 Hours
	Spacing	16mm
	# per foot (304mm)	18
<b>Design</b>	Dimensions (Inches)	.47" W
	Dimensions (Millimeters)	12mm W
	Max Single Run Length	20Ft
	Custom Cuttable	4"
	Approved Location	Indoor
<b>Warranty</b>		6 years
<b>Approvals</b>		cETLus

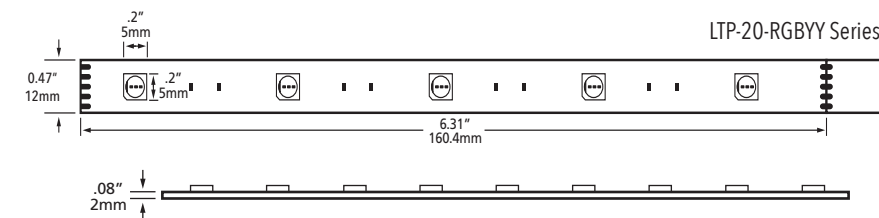

## PRODUCT CODES

XX: Length in feet; YY: Colour temperature

20Ft spools  
LTP - 20 - RGBYY - H90

100Ft spools  
LTP - 100 - RGBYY - H90

Custom Cut  
LTP - XX - RGBYY - H90

LED COLOUR  
3000K  
4000K  
6500K

LED COLOUR  
3000K  
4000K  
6500K

LED COLOUR  
3000K  
4000K  
6500K

## ACCESSORIES



**LTP-001-RGBW-6**  
72" Power feed connector for RGBW indoor



**LTP-002-RGBW**  
In-line connector for RGBW indoor



**LTP-001-RGBW-6IN**  
6" In-line connector for RGBW indoor



**LT-WIFI-RM**  
4-Zone RGB+CCT Remote



**LT-WIFI-CTRL**  
3 IN 1 LED Strip Controller (WiFi+2.4G)

**LTP-001-RGBW-12**  
144" Power feed connector for RGBW indoor



**LT-WIFI-AMP**  
WiFi Signal Amplifier for RGB, RGBW, CCT



**LT-490A**  
Signal Amplifier for RGBW

**NOTE:** See page 36-37 for the complete range of aluminum extrusions.

## NON-DIMMABLE DRIVERS

**MLDR-120-24**  
Indoor/Outdoor driver  
Max. recommended load 90W or 20' (6.1m) per single tap, 120W or 27' (8.23m) combined two secondary taps.  
120W hardwire  
Input: 100 - 240V AC  
Output: 24V DC  
10" x 3 3/8" x 3 3/16" (254 x 85.7 x 80.9mm)

**MLDR-20-24JB**  
Indoor driver  
Max recommended load 18W or 4' LED Strip  
20W hardwire  
Input: 100 - 240V AC  
Output: 24V DC  
4 1/8" x 4 1/8" x 1 1/2" (104.8 x 104.8 x 38.1mm)



# Low Power Indoor

Great choice for under cabinet and coves offering subtle lighting effects.



## FEATURES

- 1 Bin
- 2 Step MacAdam Ellipse
- 3oz PCB board
- 3M Adhesive
- 50,000 hours life
- High brightness 5060 SMD LEDs
- Field cuttable
- Low power consumption
- Available in 20' (6.1m) and 100' (30.48m) spools (custom cuts available)
- Safe, 24V class 2 power supplies (sold separately)
- Fully dimmable with dimmable power supplies (sold separately)
- 20' spools come with 6 ft. pre-soldered power feeds
- 6 years limited warranty

## APPLICATIONS

- Aisle and stairway lighting
- Cabinet and cove lighting
- Back lighting
- Showcase lighting
- Linear decorative lighting

## SPECIFICATIONS

Product Code		LTP-XX-YY-H90-LP and LTP-XX-YY-LP (XX: Length in feet; YY: Colour temperature)
Electrical	Input Voltage	24V DC
	Power Consumption	2.2W/Ft
Specs	Colour Temperature	2700/3000/3500/4000/6500K
	CRI	90+ [Note: For LTP-XX-YY-LP series, the CRI is 80]
	Lumen Output	143 Lumens per ft 2700K; 145 Lumens per ft 3000K; 148 Lumens per ft 3500K; 150 Lumens per ft 4000K; 165 Lumens per ft 6500K
	Efficacy	65 LPW 2700K, 66 LPW 3000K, 68 LPW 3500K 70 LPW 4000K, 75 LPW 6500K
	Dimmable	Yes
	Beam Angle	120°
LED	Type	High Brightness 5060 SMD LEDs
	Life Span	50,000 Hours
	Spacing	32mm
	# per foot (304mm)	9
Design	Dimensions (Inches)	.39" W
	Dimensions (Millimeters)	10mm W
	Max Single Run Length	90Ft
	Custom Cuttable	1.3" (33mm)
	Approved Location	Indoor
Warranty	6 years	
Approvals	cETLus	

## PRODUCT CODES

XX: Length in feet; YY: Colour temperature

20Ft spools  
LTP - 20 - YY - H90 - LP

LED COLOUR  
2700K  
3000K  
3500K  
4000K  
6500K

100Ft spools  
LTP - 100 - YY - H90 - LP

LED COLOUR  
2700K  
3000K  
3500K  
4000K  
6500K

Custom Cut  
LTP - XX - YY - H90 - LP

LED COLOUR  
2700K  
3000K  
3500K  
4000K  
6500K

LTP - 20 - YY - LP

LED Colour  
RD: Red  
AM: Amber  
GR: Green  
BL: Blue

LTP - 100 - YY - LP

LED Colour  
RD: Red  
AM: Amber  
GR: Green  
BL: Blue

LTP - XX - YY - LP

LED Colour  
RD: Red  
AM: Amber  
GR: Green  
BL: Blue

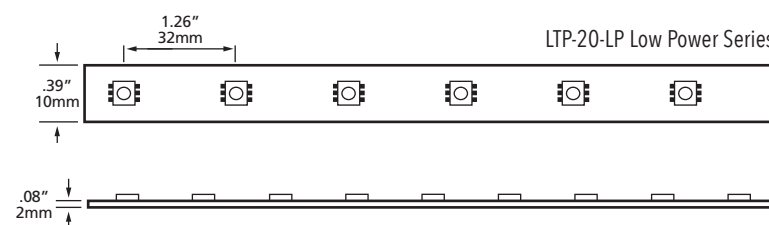

## DIMMABLE DRIVERS

### MLDRE-40-24-DM

Max recommended load 36W or 16' LED Strip, min 8W or 4' LED Strip  
6.77" x 2.67" x 1.26" (171 x 68 x 32mm)

### MLDRE-96-24-DM

Max recommended load 90W or 40' LED Strip, min 8W or 4' LED Strip  
6.77" x 2.67" x 1.26" (171 x 68 x 32mm)

## NON-DIMMABLE DRIVERS

### MLDR-120-24

Indoor/Outdoor driver  
Max. recommended load 90W or 40' (12.1m) per single tap, 120W or 54' (16.46m) combined two secondary taps.  
120W hardwire  
Input: 100 - 240V AC  
Output: 24V DC  
10" x 3 3/8" x 3 3/16" (254 x 85.7 x 80.9mm)

### MLDR-20-24JB

Indoor driver  
Max recommended load 18W or 8' LED Strip  
20W hardwire  
Input: 100 - 240V AC  
Output: 24V DC  
4 1/8" x 4 1/8" x 1 1/2" (104.8 x 104.8 x 38.1mm)

## ACCESSORIES



### LTP-001-6R

72" Power feed connector for single colour indoor. Add "-L" to code for opposite end, add "-CM" for through wall connections.



### LTP-002

In-line connector for CCT series indoor



### VO-C10-8

Clear PVC mounting "U" channel



### LTP-001-12R

12' (144") Power feed connector for single colour indoor.

### LTP-STP-6IN

5.9" (15cm)

### LTP-STP-2IN

2" (5cm)

### LTP-STP-2

2' (61cm)

### LTP-STP-12

12' (3.65m)



### LMSII-001

Terminal block and junction box for connection to additional lengths of power cable if needed



### LTP-003-6DC

DC connector for LED strip series with 6" wire and DC connector

### LTP-STP-2

2' (61cm)

### LTP-STP-12

12' (3.65m)

### LTP-003-6DC

In-line connector for single colour indoor



### LV-SPIR-1CH-LV

PIR Motion Sensor, 1 Channel, 24V DC  
NOTE: To be used with non dimmable drivers only

# Low Power Outdoor

This exterior rated tape offers more subtle illumination approach for commercial, hospitality and residential usage.



## FEATURES

- 1 Bin
- 2 Step MacAdam Ellipse
- 3oz PCB board
- 3M Adhesive
- 50,000 hours life
- High brightness 5060 SMD LEDs
- Field cuttable
- Low power consumption
- Available in 20' (6.1m) spools
- Safe, 24V class 2 power supplies (sold separately)
- Fully dimmable with dimmable power supplies (sold separately)
- 6 year limited warranty

## APPLICATIONS

- Aisle and stairway lighting
- Cabinet and cove lighting
- Back lighting
- Showcase lighting
- Linear decorative lighting

## SPECIFICATIONS

<b>Product Code</b>		LTP-OD-20-YY-H90-LP (YY: Colour temperature)	
<b>Electrical</b>	Input Voltage	24V DC	
	Power Consumption	2.2W/Ft	
<b>Specs</b>	Colour Temperature	2700/3000/3500/4000/6500K	
	CRI	90+	
	Lumen Output	143 Lumens per ft 2700K; 145 Lumens per ft 3000K; 148 Lumens per ft 3500K;	
		150 Lumens per ft 4000K; 165 Lumens per ft 6500K	
	Efficacy	65 LPW 2700K, 66 LPW 3000K, 68 LPW 3500K 70 LPW 4000K, 75 LPW 6500K	
	Dimmable	Yes	
Beam Angle	120°		
<b>LED</b>	Type	High Brightness 5060 SMD LEDs	
	Life Span	50,000 Hours	
	Spacing	1.26" (32mm)	
	# per foot (304mm)	9	
<b>Design</b>	Dimensions (Inches)	.39" W	
	Dimensions (Millimeters)	10mm W	
	Max Single Run Length	90Ft	
	Custom Cuttable	6.5" (165mm)	
	Approved Location	Outdoor	
<b>Warranty</b>	6 years		
<b>Approvals</b>	cETLus		

NOTE: Outdoor Strip Series comes with liquid-tight connectors pre-installed on both ends, so it is necessary to make the cuts starting from extremities. Cut pieces can be terminated, but not joined together.

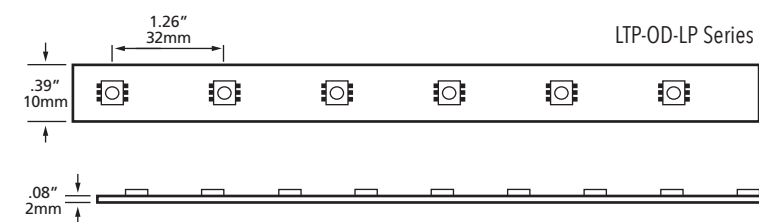

## PRODUCT CODES

YY: Colour temperature

LTP - OD - 20 - YY - H90 - LP

**LED COLOUR**  
2700K  
3000K  
3500K  
4000K  
6500K

## ACCESSORIES



**LTP-001-OD-6FT**  
72" Power feed connector for single colour outdoor



**LV-FS-MC-004**  
Mounting clips



**LV-FS-EC-001**  
End caps



**VO-C10-8**  
Clear PVC mounting "U" channel

NOTE: See page 36-37 for the complete range of aluminum extrusions.

## INDOOR/OUTDOOR DIMMABLE DRIVERS

## NON DIMMABLE DRIVERS

### MLDRE-40-24-DM

Max 7' (2.1m)  
Min 8 Watts, 1.5'(0.45M) LED High Efficacy Strip  
6.77" x 2.67" x 1.26" (171 x 68 x 32mm)

### MLDRE-96-24-DM

Max recommended load 90W or 16' LED Strip,  
min 8W or 2' LED Strip  
6.77" x 2.67" x 1.26" (171 x 68 x 32mm)

NOTE: For outdoor installations, please add E-KO-SR strain relief (2pcs/driver).

### MLDR-120-24

Indoor/Outdoor driver  
Max 17.6 (5.3m) per single tap  
Max 23' (7m) combined 2 secondary taps  
Input: 100 - 240V AC  
Output: 24V DC  
10" x 3 3/8" x 3 3/16" (254 x 85.7 x 80.9mm)



# Low Power, RGB Indoor

For more subtle approaches within entertainment venues and restaurants.

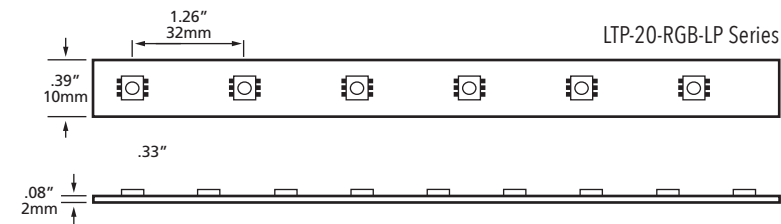

## FEATURES

- 50,000 hours life
- High brightness 5060 SMD LEDs
- Field cuttable
- Low power consumption
- Available in 20' (6.1m) and 100' (30.48m) spools (custom cuts available)
- 20' spools come with 6 ft. pre-soldered power feeds
- Safe, 24V class 2 power supplies (sold separately)
- 6 years limited warranty

## APPLICATIONS

- Aisle and stairway lighting
- Cabinet and cove lighting
- Back lighting
- Showcase lighting
- Linear decorative lighting

## SPECIFICATIONS

Product Code		LTP-XX-RGB-LP (XX: Length in feet)
Electrical	Input Voltage	24V DC
	Power Consumption	2.2W/Ft
Specs	Colour Temperature	RGB
	Dimmable	Yes
	Beam Angle	120°
LED	Type	High Brightness 5060 SMD LEDs
	Life Span	50,000 Hours
	Spacing	32mm
	# per foot (304mm)	9
Design	Dimensions (Inches)	.39" W
	Dimensions (Millimeters)	10mm W
	Max Single Run Length	90Ft
	Custom Cuttable	6.5"
	Approved Location	Indoor
Warranty	6 years	
Approvals	cETLus	

## PRODUCT CODES

XX: Length in feet

20Ft spools  
LTP - 20 - RGB - LP

100Ft spools  
LTP - 100 - RGB - LP

Custom Cuts  
LTP - XX - RGB - LP

## ACCESSORIES



**LTP-001-RGB-6R**  
72" Power feed connector for RGB indoor. Add "-L" for opposite end.

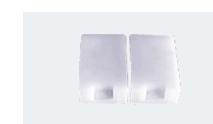

**LTP-002-RGB**  
In-line connector for RGB indoor



**VO-C10-8**  
Clear PVC mounting "U" channel



**LTP-001-RGB-6IN**  
6" In-line connector for RGB indoor



**LT-WIFI-AMP**  
WiFi Signal Amplifier for RGB, RGBW, CCT



**LT-WIFI-RM**  
4-Zone RGB+CCT Remote



**LT-WIFI-CTRL**  
3 IN 1 LED Strip Controller (WiFi+2.4G)

**LTP-001-RGB-2IN**  
2" In-line connector for RGB indoor

**NOTE:** See page 36-37 for the complete range of aluminum extrusions.

## NON-DIMMABLE DRIVERS

**MLDR-120-24**  
Indoor/Outdoor driver  
Max. recommended load 90W or 40' (12.1m) per single tap, 120W or 54' (16.46m) combined two secondary taps.  
120W hardwire  
Input: 100 - 240V AC  
Output: 24V DC  
10" x 3 3/8" x 3 3/16" (254 x 85.7 x 80.9mm)

**MLDR-20-24JB**  
Indoor driver  
Max recommended load 18W or 8' LED Strip  
20W hardwire  
Input: 100 - 240V AC  
Output: 24V DC  
4 1/8" x 4 1/8" x 1 1/2" (104.8 x 104.8 x 38.1mm)

# Low Power, RGB Outdoor

For those exterior applications requiring a dynamic but subtle approach. Suitable for residential, hospitality, commercial and retail.

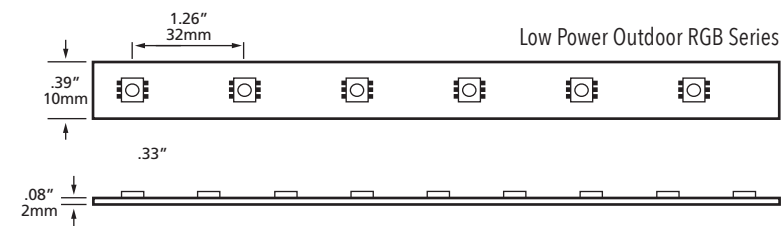
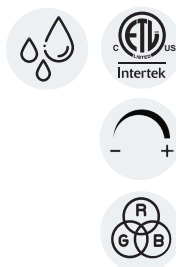

## FEATURES

- 50,000 hours life
- High brightness 5060 SMD LEDs
- Field cuttable
- Low power consumption
- Available in 20' (6.1m) spools
- Safe, 24V class 2 power supplies (sold separately)
- 6 years limited warranty

## APPLICATIONS

- Aisle and stairway lighting
- Cabinet and cove lighting
- Back lighting
- Showcase lighting
- Linear decorative lighting

## SPECIFICATIONS

<b>Product Code</b>		LTP-OD-20-RGB-LP
<b>Electrical</b>	Input Voltage	24V DC
	Power Consumption	2.2W/Ft
<b>Specs</b>	Colour Temperature	RGB
	Dimmable	Yes
	Beam Angle	120°
<b>LED</b>	Type	High Brightness 5060 SMD LEDs
	Life Span	50,000 Hours
	Spacing	32mm
	# per foot (304mm)	9
<b>Design</b>	Dimensions (Inches)	.39" W
	Dimensions (Millimeters)	10mm W
	Max Single Run Length	90Ft
	Custom Cuttable	6.5"
	Approved Location	Outdoor
<b>Warranty</b>		6 years
<b>Approvals</b>		cETLus

NOTE: Outdoor Strip Series comes with liquid-tight connectors pre-installed on both ends, so it is necessary to make the cuts starting from extremities. Cut pieces can be terminated, but not joined together.

## PRODUCT CODES

20Ft spools  
LTP - OD - 20 - RGB - LP

## ACCESSORIES



**LTP-RGB-001-OD-6FT**  
72" Power feed connector for RGB outdoor



**LV-FS-MC-004**  
Mounting clips



**LV-FS-EC-001**  
End caps



**VO-C10-8**  
Clear PVC mounting "U" channel



**LT-WIFI-RM**  
4-Zone RGB+CCT Remote



**LT-WIFI-CTRL**  
3 IN 1 LED Strip Controller (WiFi+2.4G)



**LT-WIFI-AMP**  
WiFi Signal Amplifier for RGB, RGBW, CCT

NOTE: See page 36-37 for the complete range of aluminum extrusions.

## NON-DIMMABLE DRIVERS

**MLDR-120-24**  
Indoor/Outdoor driver  
Max. recommended load 90W or 40' (12.1m) per single tap, 120W or 54' (16.46m) combined two secondary taps.  
120W hardwire  
Input: 100 - 240V AC  
Output: 24V DC  
10" x 3 3/8" x 3 3/16" (254 x 85.7 x 80.9mm)



# LED Strip Series Extrusions

These are designed to house and protect LED strip lights, enhancing durability and providing a sleek, professional finish. They also help to diffuse light evenly, preventing hotspots and creating a more aesthetically pleasing lighting effect.

## LV-ALP2208

Surface mount aluminum extrusion and frosted PC cover

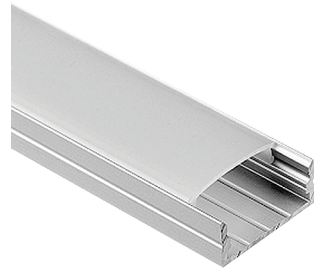

### Product Codes

LV-ALP2208  
LV-ALP2208-2M

### End Caps

LV-ALP2208-EC (2/bag)  
LV-ALP2208-EC-WF (2/bag)

### Mounting Clips

LV-ALP2208-MC (2/bag)

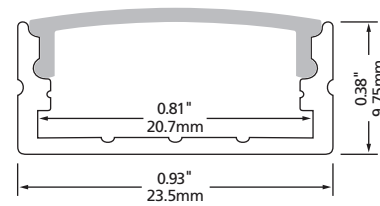

NOTE: Available in 1m (39") and 2m (78") lengths.

## LV-LB-V3-FR

Corner surface mounted aluminum extrusion and frosted PC cover

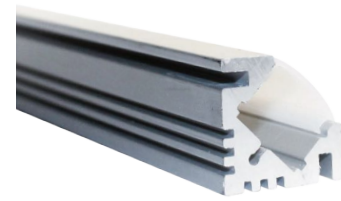

### Product Code

LV-LB-V3-FR

### End Caps

LV-V1/V3-EC (2/bag)  
LV-V1/V3-EC-WF (2/bag)

### Mounting Clips

LV-V1/V3-MC (6/bag)

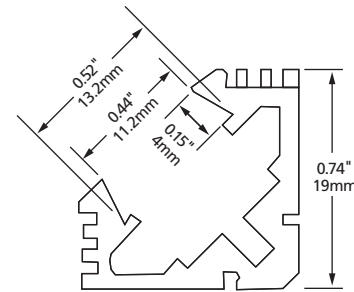

NOTE: Available in 1m (39").

## LV-RD55

Recessed aluminum extrusion



### Product Codes

LV-RD55-1M  
LV-RD55-2M

### End Caps

LV-RD54/55-EC (2/bag)  
LV-RD54/55-EC-WF (2/bag)

### Mounting Clips

LV-RD54/55-EC-MC (6/bag)

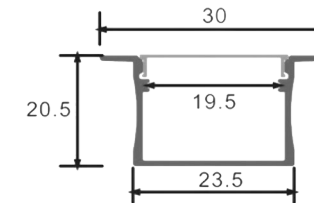

NOTE: Available in 1m (39") and 2m (78") lengths.

## LV-ALP2908

Recessed aluminum extrusion and frosted PC cover



### Product Codes

LV-ALP2908  
LV-ALP2908-2M

### End Caps

LV-ALP2908-EC (2/bag)  
LV-ALP2908-EC-WF (2/bag)

### Mounting Clips

LV-ALP2908-MC (2/bag)

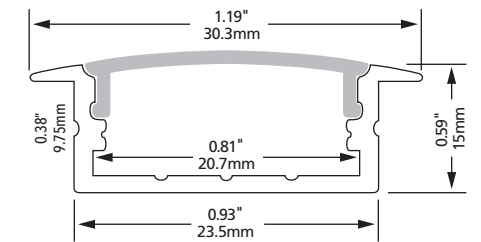

NOTE: Available in 1M (39") and 2M (78") lengths.

## LV-ALP007

Surface mount aluminum extrusion and frosted PC cover



### Product Codes

LV-ALP2207  
LV-ALP2207-2M

### End Caps

LV-ALP007-EC (2/bag)  
LV-ALP007-EC-WF (2/bag)

### Mounting Clips

LV-ALP007-MC (6/bag)

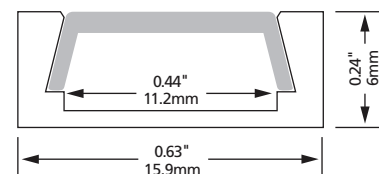

NOTE: Available in 1m (39") and 2m (78") lengths.

## LV-RD54

Surface mount aluminum extrusion

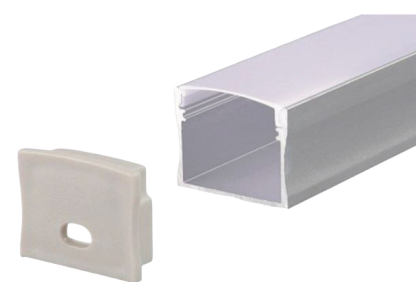

### Product Codes

LV-RD54-1M  
LV-RD54-2M

### End Caps

LV-RD54/55-EC (2/bag)  
LV-RD54/55-EC-WF (2/bag)

### Mounting Clips

LV-RD54/55-EC-MC (6/bag)

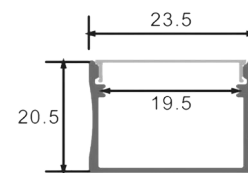

NOTE: Available in 1m (39") and 2m (78") lengths.

## LV-1401

Closet aluminum extrusion with mounting brackets and frosted PC cover

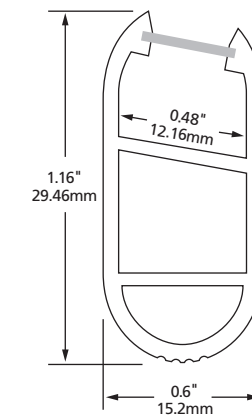

NOTE: 1M (39") extrusion ships complete with two mounting end caps and one support

# 120V AC eStrip

This field cuttable eStrip is an ideal solution for accent lighting in residential, commercial and retail applications, the 120V AC LED eStrip can be easily installed without the need of any additional driver, in indoor and outdoor applications.



## FEATURES

- Field cuttable; 120V AC input voltage
- High light efficiency, high PF and high lumens
- Constant current design, overvoltage protection
- Drop current when over temperature to protect product (Max. ambient working temperature: 55°C, light up for no more than 6 hours)
- Dimmable: TRIAC
- No need of a transformer box to change AC to DC; connect with line voltage directly

- Ambient Working Temperature: -20 ~ 42°C (-4 ~ 107°F)
- IP65 PVC extrusion process
- Min.section 4 inch; Max.run 164FT
- With bared power cords on one side, it's more convenient for connecting
- ETL certified
- 5 years warranty indoor use; 3 years warranty outdoor use

## APPLICATIONS

- Building outlines
- Signage
- Decks
- Architectural features

SPECIFICATIONS				
Product Code	ES-120V-27K-164FT	ES-120V-30K-164FT	ES-120V-40K-164FT	
Electrical	Input Voltage	120V AC		
	Power Consumption	4W/Ft		
Specs	Colour Temperature	2700K	3000K	4000K
	Lumen Output	280LM/Ft	300LM/Ft	340LM/Ft
	CRI	90+		
	Dimmable	Yes, with TRIAC dimmers		
LED	Type	SMD2835		
	Life Span	30,000 Hours		
	Spacing	N/A		
	# per foot (304mm)	18 LEDs		
Design	Dimensions (Inches)	.79" W		
	Dimensions (Millimeters)	20mm W		
	Max Single Run Length	50M (164Ft)		
	Custom Cuttable	Cuttable every 10CM (4 Inches approx.)		
	Approved Location	Indoor/Outdoor		
Warranty	5 years warranty indoor use; 3 years warranty outdoor use			
Approvals	cETLus			

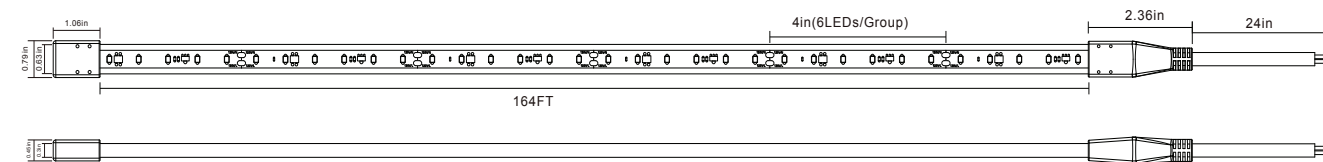

## PRODUCT CODES

XX: Length in feet; YY: Colour temperature

164 Ft spools  
ES - 120V - YY - 164FT

Custom cuts  
ES - 120V - YY - XX

LED COLOUR  
2700K  
3000K  
4000K

LED COLOUR  
2700K  
3000K  
4000K

## ACCESSORIES



**ES-120V-EC**  
End cap (Indoor & Outdoor)

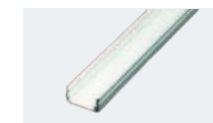

**ES-120V-EXT**  
4ft Aluminum extrusion



**ES-120V-MC**  
Mounting clips (Bag of 10)



**ES-120V-PC**  
8ft Power cord



**ES-120V-PC-PL**  
5ft Power cord with plug

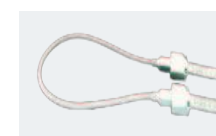

**ES-120V-JC-1FT**  
Jumper, 1Ft

**ES-120V-JC-3FT**  
Jumper, 3Ft

**ES-120V-JC-6FT**  
Jumper, 6Ft

**ES-120V-JC-6IN**  
Jumper, 6"

# Low Power eStrip

The Low Power LED eStrip, equipped with 3014 type LEDs, is a versatile linear lighting solution that offers improved brightness and performance



## FEATURES

- 40,000 hours life
- Safe low voltage (24V)
- Virtually maintenance free
- Ultra low power consumption
- Available in 40' spools (custom cuts available)
- Crushproof to 100psi
- Field cuttable
- Inter-connectable
- Highly flexible (min. bend radius 1.5")
- Indoor/outdoor use
- Impact resistant
- Dimmable
- 2 years limited warranty

## APPLICATIONS

- Building outlines
- Coves
- Stairway and aisle lighting
- Signage
- Backlit panels
- Decks
- Edgelit glow
- Emergency lighting
- Pathway lighting
- Billboards
- Highlighting architectural features
- Over/Under cabinets

## SPECIFICATIONS

<b>Product Code</b>		LES-XX-YY (XX: Length in feet; YY: Colour temperature)
<b>Electrical</b>	<b>Input Voltage</b>	24V DC
	<b>Power Consumption</b>	0.96W/Ft
<b>Specs</b>	<b>Colour Temperature</b>	3000/5800K
	<b>Lumen Output</b>	61 Lumens per ft. 5800K; 55 Lumens per ft. 3000K
	<b>LED Colours</b>	Amber, Red, Blue, Pure Green, 5800K, 3000K
	<b>PVC Body Colour</b>	Clear
	<b>Min/Max Surface Temp for Mounting</b>	-40°C - 40°C (-40°F - 104°F)
	<b>Dimmable</b>	Yes
	<b>Beam Angle</b>	120°
<b>LED</b>	<b>Type</b>	N/A
	<b>Life Span</b>	40,000 Hours
	<b>Spacing</b>	1" (25.4mm)
	<b># per foot (304mm)</b>	12
<b>Design</b>	<b>Dimensions (Inches)</b>	.25 x .5"
	<b>Dimensions (Millimeters)</b>	6 x 12mm
	<b>Max Single Run Length</b>	90Ft
	<b>Custom Cuttable</b>	6" (152.4mm)
	<b>Approved Location</b>	Indoor/Outdoor
<b>Warranty</b>		2 years
<b>Approvals</b>		cETLus

## PRODUCT CODES

XX: Length in feet; YY: Colour temperature

90Ft spools  
LES - 90 - YY

**LED eStrip LED COLOUR**  
3000K, 5800K, AM - Amber,  
BL - Blue, PG - Pure Green, RD - Red

Custom cuts  
LES - XX - YY

**LED eStrip LED COLOUR**  
3000K, 5800K, AM - Amber,  
BL - Blue, PG - Pure Green, RD - Red

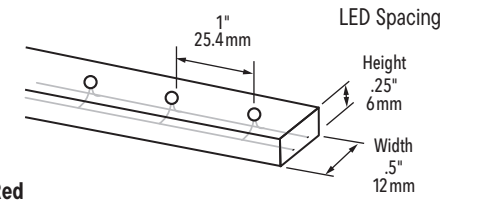

## ACCESSORIES



**LES-001-6BR**  
Outdoor 6' Power connector for burial connections, 1/4" x 1/2" (6mm x 12mm). Comes with end cap



**LES-001-12BR**  
Outdoor Power connector, with SJTW-2 12 ft wires for burial connections 1/4" x 1/2" (6mm x 12mm) Comes with end cap



**LES-STP-2BR**  
Outdoor 2' Step cord for burial connections



**LES-STP-12BR**  
Outdoor 12' Step cord (shown) for burial connections



**LES-FLEX-BR**  
Outdoor Step cord for burial connections

**LES-001-6CL**  
Indoor 6' Power connector for through wall connections

**LES-001-12CL**  
Indoor 12' Power connector for through wall connections

**LES-STP-2CL**  
Indoor 2' Step cord (shown) for through wall connections

**LES-STP-12CL**  
Indoor 12' Step cord for through wall connections

**LES-FLEX-CL**  
Indoor Step cord (shown) for through wall connections



**LES-BFTD**  
T type connector, 1/4" X 1/2" (6 x 12mm), male connector in bottom



**LES-003-2**  
Cutting end cap, 0.25" X 0.5" (6mm x 12mm)



**LMSII-001**  
Terminal block and junction box for connection to additional lengths of power cable if needed



**LES-BFLN**  
L type connector, 1/4" X 1/2" (6mm x 12mm)



**LES-002**  
In-Line connector set, male and female, 1/4" X 1/2" (6mm x 12mm)



**LES-BFXN**  
X type connector, 1/4" X 1/2" (6mm x 12mm)



**LES-BFDN**  
6 x 12mm splice kit (pins, pad and shrink tube)



**LES-BFTR**  
T type connector, 1/4" X 1/2" (6 x 12mm), male connector in right or left

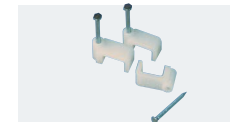

**LES-005**  
Wood nail clips, 1/4" X 1/2" (6mm x 12mm)

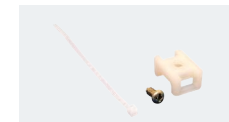

**LES-008**  
Tie wrap and mounting saddle

## INDOOR/OUTDOOR DIMMABLE DRIVERS

**Switchex®**  
LED DRIVER + DIMMER IN ONE  
A dimmer with an integrated driver that converts 120VAC to either 12VDC or 24VDC.

**MLDRE-40-24-DM**  
Max 37.5' (11.4m)  
Min 8 Watts, 9' LED eStrip (2.7m)  
6.77" x 2.67" x 1.26" (171 x 68 x 32mm)

**MLDRE-96-24-DM**  
Max 90' (27.4m)  
Min 8 Watts, 9' LED eStrip (2.7m)  
6.77" x 2.67" x 1.26" (171 x 68 x 32mm)

**NOTE:** For outdoor installations, please add E-KO-SR strain relief (2pcs/driver).



**NN-C10-POLY**  
Polycarbonate 1/2" U channel track for outdoor use



**NN-C10-8**  
PVC 1/2" U channel track for indoor use

## NON DIMMABLE DRIVERS

**MLDR-120-24 (Indoor/Outdoor)**  
Max 90' (27.4m) per single tap  
Max 120' (36.5m) combined 2 secondary taps  
Input: 100 - 240V AC  
Output: 24V DC  
10" x 3 3/8" x 3 3/16" (254 x 85.7 x 80.9mm)

**MLDR-20-24JB (Indoor)**  
Max recommended load 18W LED eStrip; Input: 100 - 240V AC  
Output: 24V DC, 20 Watts  
4 1/8" x 4 1/8" x 1 1/2" (104.8 x 104.8 x 38.1mm)



# High Power eStrip

The High Power LED eStrip is an advanced version that delivers twice the lumen output compared to the standard eSTRIP, enhancing illumination capabilities.



## FEATURES

- 40,000 hours life
- Safe low voltage (24V)
- Virtually maintenance free
- Ultra low power consumption
- Available in 40' spools (custom cuts available)
- Crushproof to 100psi
- Field cuttable
- Inter-connectable
- Highly flexible (min. bend radius 1.5")
- Indoor/outdoor use
- Impact resistant
- Dimmable
- 2 years limited warranty

## APPLICATIONS

- Building outlines
- Coves
- Stairway and aisle lighting
- Signage
- Backlit panels
- Decks
- Edgelit glow
- Emergency lighting
- Pathway lighting
- Billboards
- Highlighting architectural features
- Over/Under cabinets

## SPECIFICATIONS

<b>Product Code</b>		LESHP-XX-YY (XX: Length in feet; YY: Colour temperature)
<b>Electrical</b>	<b>Input Voltage</b>	24V DC
	<b>Power Consumption</b>	2.2W/Ft
<b>Specs</b>	<b>Colour Temperature</b>	3000/5800K
	<b>Lumen Output</b>	137 Lumens per ft 3000K; 155 Lumens per ft 5800K
	<b>LED Colours</b>	3000K and 5800K,
	<b>PVC Body Colour</b>	Clear
	<b>Min/Max Surface Temp for Mounting</b>	-40°C to 40°C (-40°F to 104°F)
	<b>Dimmable</b>	Yes
	<b>Beam Angle</b>	120°
<b>LED</b>	<b>Type</b>	N/A
	<b>Life Span</b>	40,000 Hours
	<b>Spacing</b>	1" (25.4mm)
	<b># per foot (304mm)</b>	12
<b>Design</b>	<b>Dimensions (Inches)</b>	.25 x .5"
	<b>Dimensions (Millimeters)</b>	6 x 12mm
	<b>Max Single Run Length</b>	40Ft
	<b>Custom Cuttable</b>	6" (152.4mm)
	<b>Approved Location</b>	Indoor/Outdoor
<b>Warranty</b>	2 years	
<b>Approvals</b>	cETLus	

## PRODUCT CODES

XX: Length in feet; YY: Colour temperature

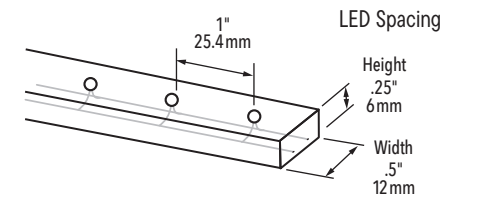
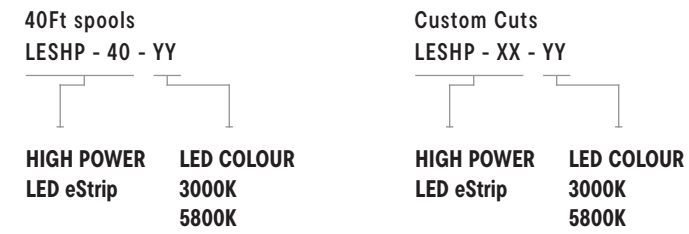

## ACCESSORIES

<p><b>LES-001-6BR</b> Outdoor 6' Power connector for burial connections, 1/4" x 1/2" (6mm x 12mm). Comes with end cap</p>	<p><b>LES-001-12BR</b> Outdoor Power connector, with SJTW-2 12 ft wires for burial connections 1/4" x 1/2" (6mm x 12mm) Comes with end cap</p>	<p><b>LES-STP-2BR</b> Outdoor 2' Step cord for burial connections</p>	<p><b>LES-STP-12BR</b> Outdoor 12' Step cord (shown) for burial connections</p>	<p><b>LES-FLEX-BR</b> Outdoor Step cord for burial connections</p>
<p><b>LES-001-6CL</b> Indoor 6' Power connector for through wall connections</p>	<p><b>LES-001-12CL</b> Indoor 12' Power connector for through wall connections</p>	<p><b>LES-STP-2CL</b> Indoor 2' Step cord (shown) for through wall connections</p>	<p><b>LES-STP-12CL</b> Indoor 12' Step cord for through wall connections</p>	<p><b>LES-FLEX-CL</b> Indoor Step cord (shown) for through wall connections</p>
<p><b>LMSII-001</b> Terminal block and junction box for connection to additional lengths of power cable if needed</p>	<p><b>LES-BFLN</b> L type connector, 1/4" X 1/2" (6mm x 12mm)</p>	<p><b>LES-002</b> In-Line connector set, male and female, 1/4" X 1/2" (6mm x 12mm)</p>		
<p><b>LES-BFTD</b> T type connector, 1/4" X 1/2" (6 x 12mm), male connector in bottom</p>	<p><b>LES-003-2</b> Cutting end cap, 0.25" X 0.5" (6mm x 12mm)</p>	<p><b>LES-BFTR</b> T type connector, 1/4" X 1/2" (6 x 12mm), male connector in right or left</p>	<p><b>LES-005</b> Wood nail clips, 1/4" X 1/2" (6mm x 12mm)</p>	<p><b>LES-008</b> Tie wrap and mounting saddle</p>
<p><b>LES-BFXN</b> X type connector, 1/4" X 1/2" (6mm x 12mm)</p>	<p><b>LES-BFDN</b> 6 x 12mm splice kit (pins, pad and shrink tube)</p>	<p><b>NN-C10-POLY</b> Polycarbonate 1/2" U channel track for outdoor use</p>	<p><b>NN-C10-8</b> PVC 1/2" U channel track for indoor use</p>	

## INDOOR/OUTDOOR DIMMABLE DRIVERS

- |  |  |
|--|--|
| <p><b>MLDRE-40-24-DM</b><br/>Max 16' (4.87m)<br/>Min 8 Watts, 4' LED eStrip (1.2m)<br/>6.77" x 2.67" x 1.26" (171 x 68 x 32mm)</p> | <p><b>MLDRE-96-24-DM</b><br/>Max 40' (12.1m)<br/>Min 8 Watts, 4' LED eStrip (1.2m)<br/>6.77" x 2.67" x 1.26" (171 x 68 x 32mm)</p> |
|--|--|

NOTE: For outdoor installations, please add E-KO-SR strain relief (2pcs/driver).

## NON DIMMABLE DRIVERS

- |   |  |
|---|--|
| <p><b>MLDR-120-24 (Indoor/Outdoor)</b><br/>Max 40' (12.1m) per single tap<br/>Max 54' (16.46m) combined 2 secondary taps<br/>Input: 100 - 240V AC<br/>Output: 24V DC<br/>10" x 3 3/8" x 3 3/16" (254 x 85.7 x 80.9mm)</p> | <p><b>MLDR-20-24JB (Indoor)</b><br/>Max recommended load 18W<br/>LED eStrip; Input: 100 - 240V AC<br/>Output: 24V DC, 20 Watts<br/>4 1/8" x 4 1/8" x 1 1/2" (104.8 x 104.8 x 38.1mm)</p> |
|---|--|

# RGB eStrip

The RGB eSTRIP, featuring RGB LEDs, enables the creation of dramatic colour change effects, suitable for building outlines and architectural highlights.



## FEATURES

- 40,000 hours life
- Safe low voltage (24V)
- Virtually maintenance free
- Ultra low power consumption
- Available in 40' spools (custom cuts available)
- Crushproof to 100psi
- Field cuttable
- Inter-connectable
- Highly flexible (min. bend radius 1.5")
- Indoor/outdoor use
- Impact resistant
- Dimmable
- 2 years limited warranty

## APPLICATIONS

- Building outlines
- Coves
- Stairway and aisle lighting
- Signage
- Backlit panels
- Decks
- Edgelit glow
- Emergency lighting
- Pathway lighting
- Billboards
- Highlighting architectural features
- Over/Under cabinets

## SPECIFICATIONS

Product Code		LES-XX-RGB (XX: Length in feet)
Electrical	Input Voltage	24V DC
	Power Consumption	2.2W/Ft
Specs	Colour Temperature	RGB
	PVC Body Colour	Clear
	Min/Max Surface Temp for Mounting	-40°C - 40°C (-40°F - 104°F)
	Dimmable	Yes
	Beam Angle	120°
LED	Type	N/A
	Life Span	40,000 Hours
	Spacing	1.3" (33mm)
	# per foot (304mm)	9
Design	Dimensions (Inches)	.3" x .6"
	Dimensions (Millimeters)	7.6 x 15mm
	Max Single Run Length	40Ft
	Custom Cuttable	8" (198mm)
Approved Location	Indoor/Outdoor	
Warranty	2 years	
Approvals	cETLus	

## PRODUCT CODES

XX: Length in feet

40Ft spools  
LES - 40 - RGB

Custom cuts  
LES - XX - RGB

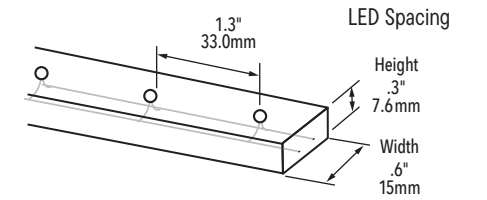

## ACCESSORIES



**LES-BTFN**  
Female connector



**LES-BTMN**  
Male connector



**LES-BTSN**  
In line connector



**LES-BTMCJ-1.5**  
1.5' Power connector



**LES-BTMCJ-6**  
6' Power connector



**LES-BTMC-G4-SI**  
Signal in connector for RGB eStrip connection to outdoor signal amplifier



**LES-BTMC-G4-SO**  
Signal out connector for RGB eStrip connection to outdoor signal amplifier



**LTP-001-OD-6FT**  
Power feed connector for connection to outdoor signal amplifier

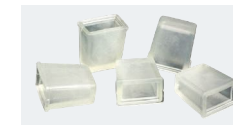

**LES-STCN**  
Cutting end cap



**LES-STFN**  
Female end cap



**LES-STPV-T**  
Clear PVC mounting "U" channel (1M)



**LES-SNPT**  
Wood nail clips, 1/4" X 1/2" (6mm x 12mm)



**LES-C-6**  
Tie wrap



**LES-MX-1**  
Allen key



**TCJ-E06**  
6' (1.8m) Extension cord

**TCJ-E30**  
30' (9.1m) Extension cord 1/4" x



**LES-TCJ-EI6-N**  
LED RGB eStrip 6" Flex Connector



**LT-WIFI-RM**  
4-Zone RGB+CCT Remote



**LT-WIFI-CTRL**  
3 IN 1 LED Strip Controller (WiFi+2.4G)



**LT-WIFI-AMP**  
WiFi Signal Amplifier for RGB, RGBW, CCT

## NON DIMMABLE DRIVERS

**MLDR-120-24 (Indoor/Outdoor)**  
Max 40' (12.1m) per single tap  
Max 54' (16.46m) combined 2 secondary taps  
Input: 100 - 240V AC  
Output: 24V DC  
10" x 3 3/8" x 3 3/16" (254 x 85.7 x 80.9mm)

**MLDR-20-24JB (Indoor)**  
Max recommended load 18W RGB LED eStrip  
Input: 100 - 240V AC  
Output: 24V DC  
20 Watts  
4 1/8" x 4 1/8" x 1 1/2" (104.8 x 104.8 x 38.1mm)

# Neon Flex

LED Neon Flex is a flexible lighting solution designed to accentuate architectural and design elements, adding colour and vibrancy to building exteriors.

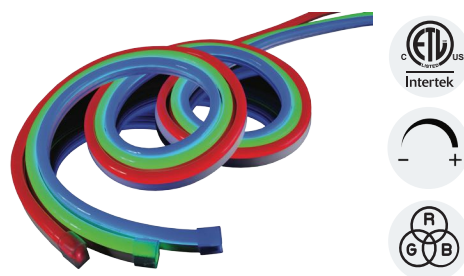

## FEATURES

- Virtually maintenance free
- Low power consumption
- Safe 24V DC operation
- cETLus certified
- Dimmable
- Inter-connectable
- Field cuttable (every 4" single colour, every 12" RGB)
- Custom cuts available
- Available in seven brilliant colours, and RGB
- Highly flexible, with neon look
- Indoor/outdoor use
- 30,000 hour life
- 3 years limited warranty

## APPLICATIONS

- Building outlines
- Stairway and aisle lighting
- Signs
- Decks
- Pathway lighting
- Billboards
- Highlighting architectural features

## SPECIFICATIONS

Product Code		NFLX-XX-YY (XX: Length in feet; YY: Colour temperature)
Electrical	Input Voltage	24V DC
	Power Consumption	2.44 W/Ft (8W/M)
Specs	Colour Temperature	3000K, 4000K, 6000K, Red, Green, Blue, Amber, RGB
	CRI	80+
	Lumen Output	300 Lumens/Ft (900 Lumens/M) (In white)
	Efficacy	25 LPW
	PVC Body Colour	Clear
	Operating Temperature	-20°C - 40°C
	Dimmable	Yes
LED	Beam Angle	120°
	Type	N/A
	Life Span	30,000 Hours
Design	# per foot (304mm)	N/A
	Dimensions (Inches)	1.04 x 0.6"
	Dimensions (Millimeters)	26.5 x 15mm
	Max Single Run Length	40Ft
	Custom Cuttable	4" Single Colour, 12" RGB
Approved Location	Indoor/Outdoor	
Warranty		3 years
Approvals		cETLus

PRODUCT CODES ——— XX: Length in feet; YY: Colour temperature

NFLX - 40 - YY  
NFLX - XX - YY

LED Neon Flex Length Colour  
3000K, 4000K, 6000K, RD - Red, GR - Green, BL - Blue, AM - Amber, RGB - RGB

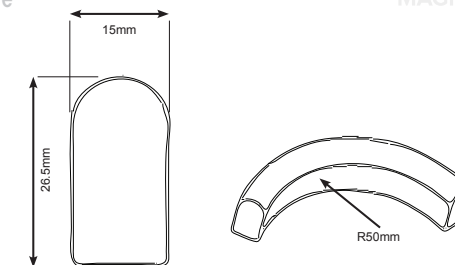

## ACCESSORIES (SINGLE COLOUR)

<b>NFLX-CONKIT-6FT</b> Power feed connector, 6FT	<b>NFLX-JUMP</b> Jumper connector, 15CM [6in]	<b>NFLX-PINS</b> Single colour pins	<b>NFLX-SPLICE</b> In-line splice connector	<b>NFLX-L-SPLICE</b> L splice connector
<b>NFLX-T-SPLICE</b> T splice connector	<b>NFLX-ENDS</b> End cap	<b>NFLX-CLIPS</b> Mounting clips	<b>NFLX-CHANNEL</b> Aluminum mounting channel 1M [3.28FT]	<b>NFLX-GLUE</b> Silicone Glue

## ACCESSORIES (RGB)

<b>NFLX-RGB-CONTROL</b> RGB controller	<b>NFLX-RGB-AMP</b> RGB signal amplifier	<b>NFLX-RGB-CONKIT-6FT</b> RGB power feed connector, 6FT	<b>NFLX-RGB-CONKIT-6FT-O</b> RGB power feed connector, 6FT, opposite	<b>NFLX-RGB-JUMP</b> RGB Jumper connector, 15cm (6 Inches)	<b>LT-WIFI-RM</b> 4-Zone RGB+CCT Remote	<b>LT-WIFI-CTRL</b> 3 IN 1 LED Strip Controller (WiFi+24G)
<b>NFLX-PINS</b> Single colour pins	<b>NFLX-ENDS</b> End cap	<b>NFLX-CLIPS</b> Mounting clips	<b>NFLX-RGB-CHANNEL</b> Aluminum mounting channel 1M [3.28FT]	<b>NFLX-GLUE</b> Silicone Glue	<b>LT-WIFI-AMP</b> WiFi Signal Amplifier for RGB, RGBW, CCT	

## INDOOR/OUTDOOR DIMMABLE DRIVERS

**MLDRE-40-24-DM**  
Max 14.5' (4.4m)  
Min 8 Watts, 3.3'(1M) LED Neon Flex  
6.77" x 2.67" x 1.26" (171 x 68 x 32mm)

**MLDRE-96-24-DM**  
Max 40' (12m)  
Min 8 Watts, 3.3'(1m) LED Neon Flex  
6.77" x 2.67" x 1.26" (171 x 68 x 32mm)

## NON DIMMABLE DRIVERS

**MLDR-120-24**  
Indoor/Outdoor driver  
Max 40' (12m) per single tap  
Max 48' (14.6m) combined 2 secondary taps  
Input: 100 - 240V AC  
Output: 24V DC  
10" x 3 3/8" x 3 3/16" (254 x 85.7 x 80.9mm)

**MLDR-20-24JB**  
Indoor driver  
Max recommended load 18W 7.3'(2.2m)  
LED Neon Flex  
Input: 100 - 240V AC  
Output: 24V DC  
20 Watts  
4 1/8" x 4 1/8" x 1 1/2" (104.8 x 104.8 x 38.1mm)

NOTE: For outdoor installations, please add E-KO-SR strain relief (2pcs/driver).



# Globe Light

The LED Globe Light, characterized by its marquee-style design, serves as a decorative lighting option equipped to endure extreme weather conditions, offering durability and longevity for both indoor and outdoor use.



## FEATURES

- 50,000 hours life
- Low power consumption
- Safe class 2, 24V power supply
- Field cuttable
- Multiple lamp spacings available
- Durable construction for indoor and outdoor use
- 2 years limited warranty

## APPLICATIONS

- Building outlines
- String across patios, walk ways, streets and public areas
- Under soffits
- Bridges
- Architectural features
- Window decorations
- Decks and patios

## SPECIFICATIONS

Product Code		MGST-12-Y (Y: Colour temperature)
Electrical	Input Voltage	24V DC
	Power Consumption	.5W/Bulb
Specs	Colour Temperature	2700/6000K
	CRI	80+
	Lumen Output	50 Lumens/Bulb
	LED Colours	2700K, 6000K, Red, Blue, Green, Amber (Upon request)
	Efficacy	100 Lumens per watt
	Wiring	Directly wired to class 2, 24V power supply
	Dimmable	Yes
	Cable	PVC black SPT2, 16AWG outdoor rated
Design	Life Span	50,000 Hours
	Spacing	12"
	# per foot (304mm)	1
	Dimensions (Inches)	1.77 x 2.76"
Design	Dimensions (Millimeters)	45 x 70mm
	Finish	Black
	Max Single Run Length	150' (45.6M) Not to exceed 180 lamps
	Operating Temperature	-25°C to 65°C
	Approved Location	Indoor/Outdoor
	Warranty	2 years
Approvals	cETLus	

## PRODUCT CODES

Y: Colour temperature

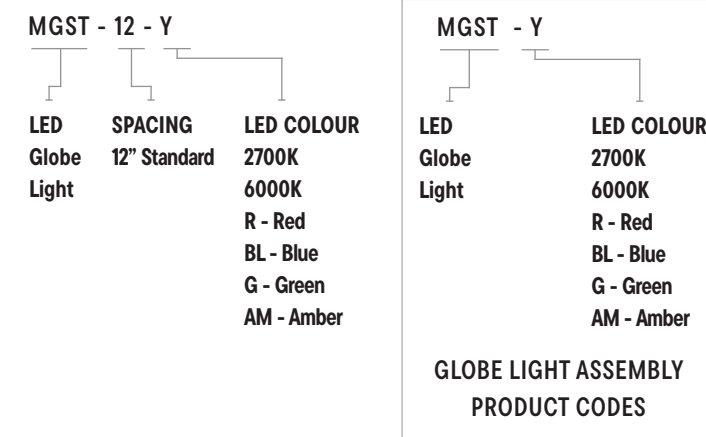

**OUTDOOR RATED CABLE: ST16W**  
For attaching Globe Light Lamp Assemblies.

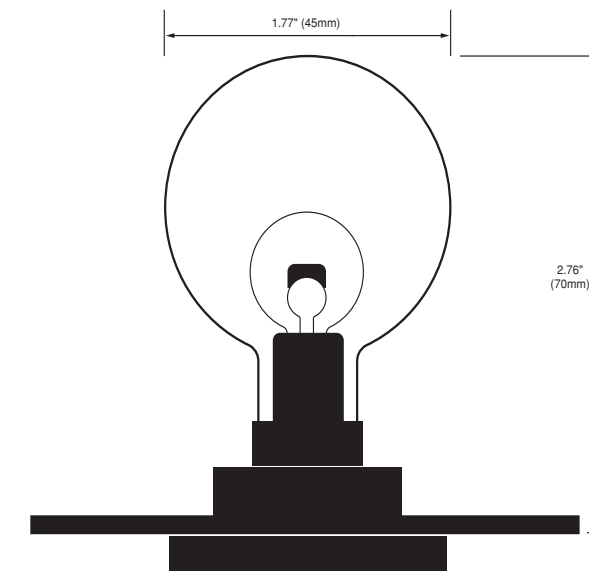

## ACCESSORIES



**MGNC**  
Wood nail mounting clip



**MGEC**  
End cap for wire (Bag of 10)



**MGWC**  
Tie wrap for mounting to wire



**ST16W**  
Outdoor rated cable for DIY mounting of LED Globe Light



**MGTP**  
Double sided tape (Bag of 50 pieces)



**MGST-XX-LAMP**  
Replacement lamp (XX: 2700K, 6000K, R (Red), BL (Blue), G (Green), AM (Amber))

## INDOOR/OUTDOOR DIMMABLE DRIVERS

**MLDRE-40-24-DM**  
Min 8 Watts, 16 Globes  
Max number of Globes = 80  
40 Watts  
6.77" x 2.67" x 1.26" (171 x 68 x 32mm)

**MLDRE-96-24-DM**  
Min 8 Watts, 16 Globes  
Max number of Globes = 180  
96 Watts  
6.77" x 2.67" x 1.26" (171 x 68 x 32mm)

## NON DIMMABLE DRIVERS

**MLDR-120-24 (Indoor/Outdoor)**  
Max number of Globes = 180\*  
120W hardwire  
Input: 100 - 240V AC, Output: 24V DC  
120 Watts  
10" x 3 3/8" x 3 3/16" (254 x 85.7 x 80.9mm)

**MLDR-20-24JB (Indoor)**  
Max recommended load 18W or 36 LED Globes  
20W hardwire  
Input: 100 - 240V AC, Output: 24V DC  
4 1/8" x 4 1/8" x 1 1/2" (104.8 x 104.8 x 38.1mm)

\* 180 on a single tap or 200 combined two secondary taps.

# Wedge Light

The LED Wedge Light is designed as a durable lighting solution for all weather conditions, making it suitable for outlining buildings and various decorative lighting projects. Its robust construction ensures reliable performance in diverse environments.



## FEATURES

- 50,000 hours life
- Low power consumption
- Safe class 2, 12V power supply
- Field cuttable
- Multiple lamp spacings available
- Durable construction for indoor and outdoor use
- Available in Cool White and Warm White
- Optional Red, Blue, Green & Amber LEDs are also available
- 2 years limited warranty

## APPLICATIONS

- Building outlines
- Under soffits
- Bridges
- Architectural features
- Coves
- Window decorations
- Decks and patios

## SPECIFICATIONS

Product Code		MGST-12-Y (Y: Colour temperature)
Electrical	Input Voltage	12V DC
	Power Consumption	.25W/Bulb
Specs	Colour Temperature	2700/6000K
	CRI	80+
	Lumen Output	15 Lumens/Bulb
	LED Colours	2700K, 6000K, Red, Blue, Green, Amber (Upon request)
	Efficacy	60 Lumens per watt
	Wiring	Directly wired to class 2, 24V power supply
	Dimmable	Yes
	Cable	PVC black SPT2, 16AWG outdoor rated
Design	Life Span	50,000 Hours
	Spacing	6"
	# per foot (304mm)	2
	Dimensions (Inches)	1.02" x 1.46"
	Dimensions (Millimeters)	26 x 37mm
Design	Finish	Black
	Max Single Run Length	100' (45.6M) Not to exceed 200 lamps
	Operating Temperature	-25°C to 65°C
	Approved Location	Indoor/Outdoor
Warranty		2 years
Approvals		cETLus

## PRODUCT CODES

Y: Colour temperature

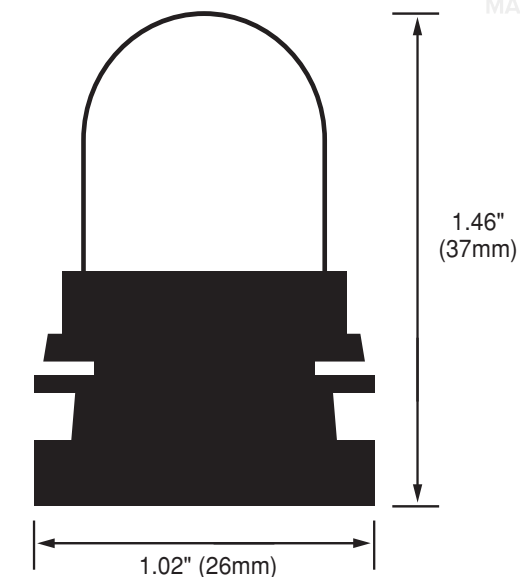
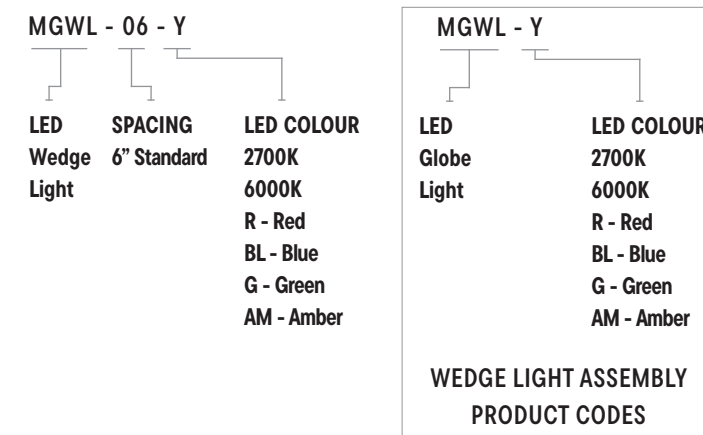

## ACCESSORIES



**MGNC**  
Wood nail mounting clip



**MGEC**  
End cap for wire (Bag of 10)



**MGWC**  
Tie wrap for mounting to wire



**ST16W**  
Outdoor rated cable for DIY mounting of LED Wedge Light



**MGTP**  
Double sided tape (Bag of 50 pieces)



**MGWL-XX-LAMP**  
Replacement lamp (XX: 2700K, 6000K, R (Red), BL (Blue), G (Green), AM (Amber))

## INDOOR/OUTDOOR DIMMABLE DRIVERS

**MLDRE-20-12-DM**  
Min 8 Watts, 32 Wedges  
Max number of Wedges = 80  
20 Watts  
6.77" x 2.67" x 1.26" (171 x 68 x 32mm)

**MLDRE-60-12-DM**  
Min 8 Watts, 32 Wedges  
Max number of Wedges = 200  
60 Watts  
6.77" x 2.67" x 1.26" (171 x 68 x 32mm)

NOTE: For outdoor installations, please add E-KO-SR strain relief (2pcs/driver).

## NON DIMMABLE DRIVERS

**LEDDR-12-60W**  
Indoor/Outdoor driver  
Max number of Wedges = 200  
60W hardwire  
Input: 100 - 240V AC  
Output: 12V DC  
9 11/16" x 2 9/16" x 2 1/16" (246 x 65 x 52mm)

**LEDDR-12-20W-HW**  
Indoor driver  
Max number of Wedges = 80  
20W hardwire  
Input: 100 - 240V AC  
Output: 12V DC  
4 1/8" x 4 1/8" x 1 1/2" (104.8 x 104.8 x 38.1mm)

# 24V Wall Washer

The 24V LED Wall Washer is engineered for illuminating architectural features, signage, and landscapes with its advanced lighting capabilities. It provides a versatile solution for both indoor and outdoor spaces, combining functionality with aesthetic enhancement.

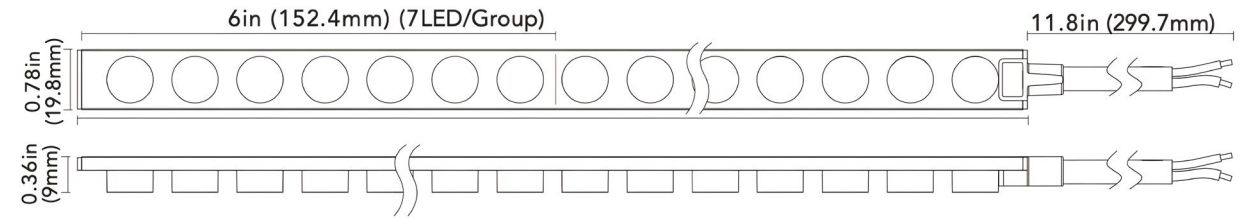

## FEATURES

- Safe 24V DC operation (Requires our 24V driver)
- Low power consumption: 5.8W/FT
- Suitable for indoor and outdoor use
- Beam angle: 30°
- Available in 2700K, 3000K, 4000K colour temperatures
- Long life 30,000 hours
- Dimmable with dimmable drivers
- Field cuttable every 6" (Maximum run is 16ft.)
- Sold in 33 Rolls
- cULus certified for wet locations
- 3 years limited warranty

## APPLICATIONS

- Architectural lighting
- Signage
- Landscape lighting
- Exterior/interior commercial

## SPECIFICATIONS

Product Code	ES-LS2835-27K-42-24-30	ES-LS2835-30K-42-24-30	ES-LS2835-40K-42-24-30	
<b>Electrical</b>	Input Voltage	24V DC		
	Power Consumption	5.8W/Ft		
<b>Specs</b>	Colour Temperature	2700K	3000K	4000K
	Efficacy	100LM/W	105LM/W	110LM/W
	Luminous Flux	580LM/FT	610LM/FT	640LM/FT
	CRI	90+		
	Dimmable	Yes		
	Beam Angle	30°		
<b>LED</b>	Type	SMD2835		
	Life Span	30,000 Hours		
	Spacing	N/A		
	# per foot (304mm)	14		
<b>Design</b>	Dimensions	8mm (5/16") x 15mm (9/16")		
	Max Single Run Length	16Ft		
	Custom Cuttable	Every 6"		
	Approved Location	Indoor/Outdoor		
<b>Mounting</b>	Ceiling, floor			
<b>Warranty</b>	3 years			
<b>Approvals</b>	cULus for wet locations			

## PRODUCT CODES

ES - LS2835 - 27K - 42 - 24 - 30

ES - LS2835 - 30K - 42 - 24 - 30

ES - LS2835 - 40K - 42 - 24 - 30

## ACCESSORIES



**NFLX-GLUE**  
Glue



**ES-EC**  
End Cap



**ES-MC**  
Mounting Clips  
(4pcs/bag)



**ES-WB**  
Wall Washer Wall Bracket Set  
(2 pieces)



**ES-PFC-6FT**  
Power Feed Connector



**ES-JC-6IN 6IN,**  
**ES-JC-12IN 12IN,**  
**ES-JC-3FT 3FT,**  
**ES-JC-6FT 6FT**  
Jumper Cable

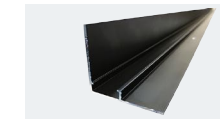

**ES-EXT**  
ES-EXT Aluminum extrusion (8FT), anodized black, for ceiling or floor mounting. For wall mounting, please see the wall mounting brackets

**ES-EXT-XX**  
For shorter lengths.

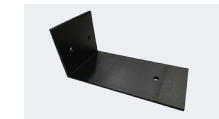

Three wall mounting brackets available to enhance the wall washing effect (2 pieces):  
**ES-MB-2IN 2IN**  
**ES-MB-4IN 4IN**  
**ES-MB-6IN 6IN**  
Wall Mounting Bracket

## INDOOR/OUTDOOR DIMMABLE DRIVERS

**MLDRE-40-24-DM**  
6.77" x 2.67" x 1.26" (171 x 68 x 32mm)

**MLDRE-96-24-DM**  
6.77" x 2.67" x 1.26" (171 x 68 x 32mm)

## NON DIMMABLE DRIVERS

**MLDR-120-24 (Indoor/Outdoor)**  
120W hardwire  
Input: 100 - 240V AC  
Output: 24V DC  
10" x 3 3/8" x 3 3/16" (254 x 85.7 x 80.9mm)

NOTE: For field cuttability you will need power supply cap, End cap and potentially jumper cables. All termination points must be glued with our NFLX-GLUE. Please reach out if you have any questions, we would be happy to help.



# Wall Washer 4' Enclosed

This a type of lighting fixture designed to evenly distribute light over a wall or vertical surface. Enclosed within a 4-foot-long casing, this wall washer is designed for durability and protection against dust, moisture, and other environmental factors.



## FEATURES

- Safe 24V DC operation (Requires our 24V driver)
- Low power consumption: 5.8W/FT
- Suitable for indoor and outdoor use
- Beam angle: 30°
- Available in 2700K, 3000K, 4000K colour temperatures
- Long life 30, 000 hours
- Dimmable with dimmable drivers
- Sold in 33 Rolls
- cULus certified for wet locations
- 3 years limited warranty

## APPLICATIONS

- Architectural lighting
- Signage
- Landscape lighting
- Exterior/interior commercial

## SPECIFICATIONS

<b>Product Code</b>		ES-LS2835-30-WH-24-4FT
<b>Electrical</b>	Input Voltage	24V DC
	Power Consumption	5.8W/Ft
<b>Specs</b>	Colour Temperature	3000K
	CRI	90+
	Efficacy	105LM/W
	Luminous Flux	610LM/FT
	Dimmable	Yes
	Beam Angle	30°
<b>LED</b>	Type	SMD2835
	Life Span	30,000 Hours
	Spacing	N/A
	# per foot (304mm)	14
<b>Design</b>	Dimensions (Inches)	5/16' x 9/16"
	Dimensions (Millimeters)	8 x 15mm
	Max Single Run Length	N/A
	Custom Cuttable	N/A
	Approved Location	Indoor/Outdoor
	Mounting	Ceiling, floor
<b>Warranty</b>	6 years	
<b>Approvals</b>	cULus for wet locations	

## PRODUCT CODES

ES - LS2835 - 30 - WH - 24 - 4FT

## ACCESSORIES



**ES-WB**  
Wall bracket set



**ES-ADJ-BR**  
Adjustable bracket (Rotatable)

## INDOOR/OUTDOOR DIMMABLE DRIVERS

**MLDRE-40-24-DM**  
6.77" x 2.67" x 1.26" (171 x 68 x 32mm)

**MLDRE-96-24-DM**  
6.77" x 2.67" x 1.26" (171 x 68 x 32mm)

## NON DIMMABLE DRIVERS

**MLDR-120-24 (Indoor/Outdoor)**  
120W hardwire  
Input: 100 - 240V AC  
Output: 24V DC  
10" x 3 3/8" x 3 3/16" (254 x 85.7 x 80.9mm)





# Under Cabinet Lighting



# 5CCT LED Task Bar

For those seeking high performance LED under cabinet lighting fixture, the 5CCT LED Task Bar offers customizable lighting, true colour representation, energy efficiency, easy installation, versatility, and durability.



## FEATURES

- Available in white finish
- Life: 35,000 Hours
- Plug and hardwire power cords available (sold separately)
- Easy installation
- 5 position switch for colour temperature adjustment
- Slim profile
- Dimmable with TRIAC dimmers
- Linkable up to 200W using end to end connectors or jumper cords
- Jumper cords available (sold separately)

## APPLICATIONS

- Under cabinet task light
- Over cabinet accent light
- Display cases and exhibits
- Merchandising
- Wall units and bars
- Office work stations

## SPECIFICATIONS

		10"	12"	18"	24"	36"	48"
<b>Product code</b>	LEDLB-5CCT-XX	LEDLB-5CCT-10	LEDLB-5CCT-12	LEDLB-5CCT-18	LEDLB-5CCT-24	LEDLB-5CCT-36	LEDLB-5CCT-48
<b>Electrical</b>	Input Voltage	120V AC					
	Power Consumption	3.5W	5W	8W	12W	16W	20W
	Max Wattage per run	200W					
<b>Specs</b>	Colour Temperature	2700/3000/3500/4000/5000K					
	CRI	90					
	Lumen Output	290	443-541	652-771	966-1134	1199-1393	1599-1892
	Efficacy (Lm/W)	82.8	98.4	88.75	82.5	81.25	87.5
	Dimmable	Yes, with TRIAC dimmers					
	Beam Angle	110°					
	<b>LED</b>	Type	SMD2835				
	Life Span	35,000 Hours					
	Spacing	N/A					
	# per foot / unit	N/A					
<b>Design</b>	Dimensions Inches (l/h/w)	9 3/4; 1 5/16; 13/16"	12 3/8; 1 5/16; 13/16"	17 1/2; 1 5/16; 13/16"	22 5/8; 1 5/16; 13/16"	34 7/16; 1 5/16; 13/16"	46 1/4; 1 5/16; 13/16"
	Dimensions mm (l/h/w)	247 / 33 / 20mm	315 / 33 / 20mm	445 / 33 / 20mm	575 / 33 / 20mm	875 / 33 / 20mm	1175 / 33 / 20mm
	Finish Colour / trims	White					
	Product Material	Aluminum and acrylic					
	Max Single Run Length	40Ft					
	Custom Cuttable	N/A					
	Operating Temperature	-20°C to 40°C					
	Approved Location	Damp					
	Mounting	Via included brackets					
<b>Warranty</b>	5 years						
<b>Approvals</b>	cETLus for indoor use						

NOTE: Only LEDLB-5CCT-18, LEDLB-5CCT-24, LEDLB-5CCT-36, and LEDLB-5CCT-48 have on/off switch.



## DIAGRAM

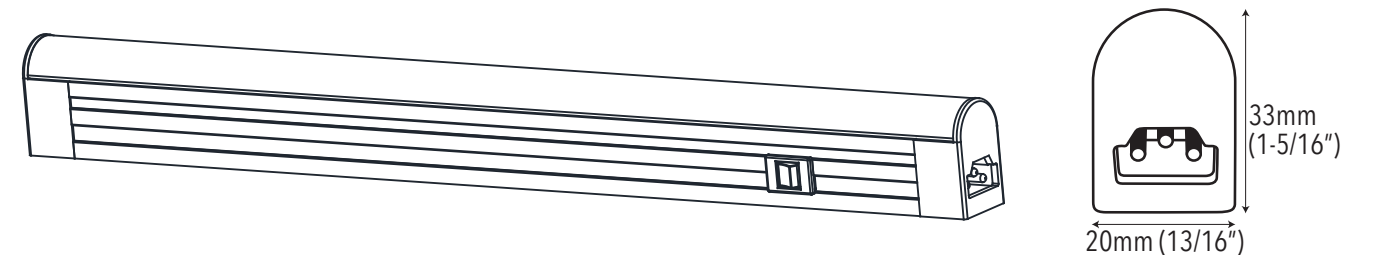

## PRODUCT CODES

LEDLB - 5CCT - XX

SIZE (INCHES)

10, 12, 18, 24, 36, 48

## ACCESSORIES



**LEDLB-J-12**  
12" Jumper Cable



**LTSPRO-PC-72**  
72" power cord and plug

**LTSPRO-HW-72**  
72" power cord for hardwire



**LTSPRO-JB**  
Hardwire junction box With ON/OFF switch

**LEDLB-J-24**  
24" Jumper Cable

**LEDLB-J-32**  
32" Jumper Cable



# Gen II LED Hard Strip

Gen II LED Hard Strip is a new and improved energy efficient linkable strip, that provides a smooth, even lighting, eliminating any hot spots. Encased in an aluminum casing, the LED's are cool to the touch and provide 120° beam spread.



## FEATURES

- 50,000 hours life
- Use high brightness 0.5W Epistar LEDs as lighting source
- Even light distribution with 120° viewing angle
- Available in 4 sizes
- Convenient connector
- between two strips
- Diffused frosted lens to reduce glare

## APPLICATIONS

- Under counter
- Display cases
- Cabinet interiors
- Work stations
- Interior decorative lighting

## SPECIFICATIONS

		300mm	500mm	1000mm	1200mm
<b>Product code</b>	LV-HS-PD20-24V-YY-XX	LV-HS-PD20-24V-30-XX*	LV-HS-PD20-24V-50-XX*	LV-HS-PD20-24V-100-XX*	LV-HS-PD20-24V-120-XX*
<b>Electrical</b>	Input Voltage	24V DC			
	Power Consumption	4W	7W	13W	16W
<b>Specs</b>	Colour Temp: Neutral White	4200K +/- 200K			
	Colour Temp: Warm White	3000K +/- 200K			
	Lumens (LM): Neutral White	400	664	1066	1150
	Lumens (LM): Warm White	380	621	1036	1100
	Viewing Angle	120°			
<b>LED</b>	Life Span	50,000 Hours			
	Qty. per strip	36	60	132	156
<b>Design</b>	Size	11.8" (300mm)	19.7" (500mm)	39.4" (1000mm)	47.3" (1200mm)
	Product Material	Aluminum			
	Operating Temperature	-35°C to 50°C			
	Mounting	2 pieces of 0° mounting clips and one end cap			
<b>Warranty</b>	3 years limited				
<b>Approvals</b>	cETLus for indoor use				

\*XX = LED colour: WW = 3000K, NW = 4200K | NOTE: Each Hard Strip bar ships with 2pcs of 0° mounting clips and one end cap.

## MOUNTING OPTIONS

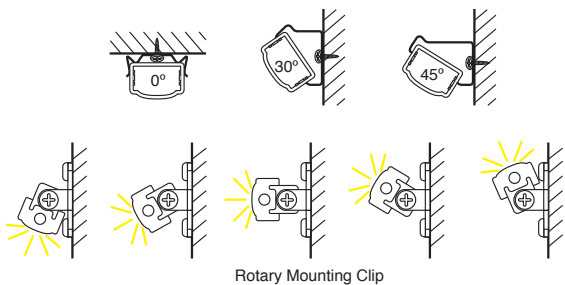

## PRODUCT CODES

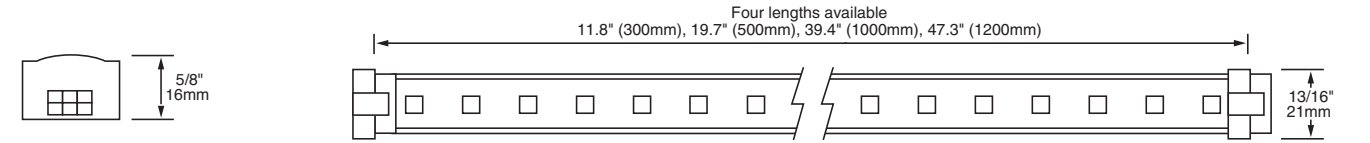
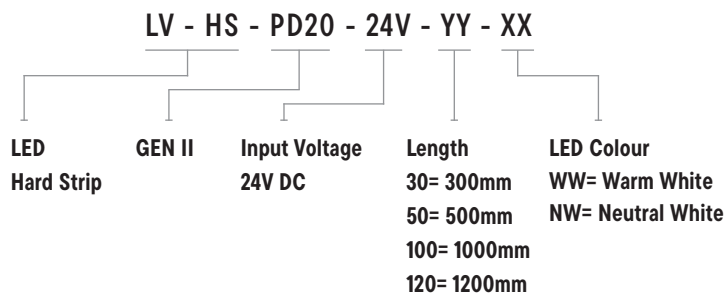

## ACCESSORIES

<p><b>LV-HS-PD20-PF1-12</b> 12" Power Feed for LED Hard Strip single colour, Bar - DC plug power supply</p>	<p><b>LV-HS-PD20-PF1-39</b> 39" Power Feed for LED Hard Strip single colour, Bar - DC plug power supply</p>	<p><b>LV-HS-PD20-PF1-HW</b> 39" Power Feed for LED Hard Strip single colour, Bar - Hard wire power supply</p>	<p><b>LV-HS-PD20-PC1-12</b> 12" Power Connector for LED Hard Strip single colour, Bar - Bar</p>	<p><b>LV-HS-PD20-PC1-39</b> 39" Power Connector for LED Hard Strip single colour, Bar - Bar</p>
<p><b>LV-HS-PD20-PC1-3</b> 3" Power Connector for LED Hard Strip Single Colour, Bar - Bar</p>	<p><b>LV-HS-CN-3DC</b> Connector for Hard Strip, with 12" wire lead and 3 DC connectors</p>	<p><b>LV-HS-CN-2DC</b> Connector for Hard Strip, with 12" wire lead and 2 DC connectors</p>	<p><b>LV-HS-EC</b> End Cap for LED Hard Strip</p>	<p><b>LV-HS-MC0</b> Mounting clip (2pk)</p>
<p><b>LV-HS-MC30</b> Mounting clip 30° (2pk)</p>	<p><b>LV-HS-MC45</b> Mounting clip 45° (2pk)</p>	<p><b>LV-HS-MCTR</b> Rotary Mounting clip (2pk)</p>		

## DIMMABLE DRIVERS

- MLDRE-40-24-DM**  
Max recommended load 36W, min. 8W LED Hard Strip 6.77" x 2.67" x 1.26" (171 x 68 x 32mm)
- MLDRE-96-24-DM**  
Max recommended load 90W, min. 8W LED Hard Strip 6.77" x 2.67" x 1.26" (171 x 68 x 32mm)
- Switchex®**  
LED DRIVER + DIMMER IN ONE  
A dimmer with an integrated driver that converts 120VAC to either 12VDC or 24VDC.

## NON DIMMABLE DRIVERS

- MLDR-120-24**  
Indoor/Outdoor driver  
Max. recommended load 90W per single tap, 120W combined two secondary taps.  
120W hardwire  
Input: 100 - 240V AC  
Output: 24V DC  
10" x 3 3/8" x 3 3/16" (254 x 85.7 x 80.9mm)
- MLDR-20-24JB**  
Indoor driver  
Max recommended load 18W  
20W hardwire  
Input: 100 - 240V AC  
Output: 24V DC  
4 1/8" x 4 1/8" x 1 1/2" (104.8 x 104.8 x 38.1mm)

# Gen II 3-Colour Change LED Task Star

Craft the perfect ambiance with Gen II LED Task Star's colour temperature control, easy-to-install features, and a 5-year warranty.



## FEATURES

- NEW: 1/2" Knockouts for easy installation
- 3 position switch for colour temperature adjustment (3000K/4000K/5000K)
- Available in 5 lengths for multiple applications
- Dimmable with most ELV dimmers.
- Captive mounting screws
- Continuous dimming with a 5%-100% dimming range
- Easy installation
- High Low switch
- 5 years limited warranty
- Available in white, black, bronze and aluminum finish

## APPLICATIONS

- Under counter
- Display cases
- Cabinet interiors
- Work stations
- Interior decorative lighting

## SPECIFICATIONS

		9.5"	17.5"	26"	34.5"	43"
<b>Product code</b>	LTS-II-Y-HW/XX	LTS-II-1-HW/XX*	LTS-II-2-HW/XX*	LTS-II-3-HW/XX*	LTS-II-4-HW/XX*	LTS-II-5-HW/XX*
<b>Electrical</b>	Input Voltage	120V AC				
	Power Consumption	5W	10W	15W	20W	25W
<b>Specs</b>	Colour Temp	3000/4000/5000K				
	CRI	90+				
	Lumens (Output)	310LM	650LM	1000LM	1300LM	1500LM
	Dimmable	Most ELV dimmers - continous dimming with a 5%-10% dimming range				
<b>LED</b>	Type	0.5W Epistar				
	Life Span	50,000 Hours				
<b>Design</b>	Dimensions (Inches)	9.5 x 4.47 x 1.54"	17.5 x 4.47 x 1.54"	26 x 4.47 x 1.54"	34.5 x 4.47 x 1.54"	43 x 4.47 x 1.54"
	Dimensions (Millimeters)	240 x 113.5 x 39mm	443.5 x 113.5 x 39mm	659.2 x 113.5 x 39	874.9 x 113.5 x 39mm	1090 x 113.5 x 39mm
	Lens	Frosted glass				
	Finish	BK-Black, BZ-Bronze, AL-Aluminum, WH-White				
	Mounting	N/A				
<b>Warranty</b>	5 years limited					
<b>Approvals</b>	cETLus and Energy Star					

\*XX = Trim Finish (see below)

## PRODUCT CODES

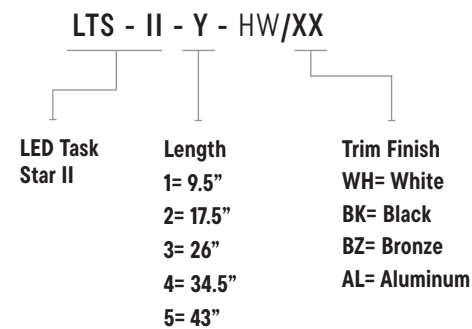

## DIAGRAM

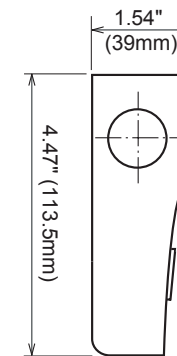
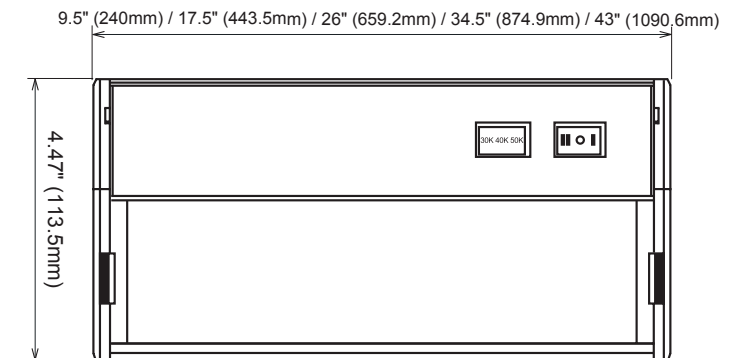

# LED Task Star PRO

LTSPRO is constructed with aluminum housing and a matte polycarbonate diffuser. This sleek fixture features edge lit technology which means no hot spots on the polished marble or granite counter top.



## FEATURES

- Long lasting 50,000 hours life
- Comes with High / Low Switch
- Low power consumption
- Edge Lit technology eliminates hot spots
- Fast and easy installation – quick connects, captive mounting holes
- Comes with cord and plug as well as knockouts for hardwire
- 3/8" connector provided
- Shallow profile conceals fixture
- Linkable up to 400 watts. Each fixture ships with 8" jumper cable and end-to-end connector
- cETLus and Energy Star listed
- 5 years limited warranty

## APPLICATIONS

- Under cabinet task light
- Over cabinet accent light
- Display cases and exhibits
- Merchandising
- Indirect accent light
- Wall units and bars

## SPECIFICATIONS

		9"	12"	18"	24"	32"	40"
<b>Product Code</b>	LTSPRO- XX-YY	LTSPRO- 9-YY*	LTSPRO- 12-YY*	LTSPRO- 18-YY*	LTSPRO- 24-YY*	LTSPRO- 32-YY*	LTSPRO- 40-YY*
<b>Electrical</b>	Input Voltage	120V AC					
	Power Consumption	3W	5W	8W	12W	16W	20W
<b>Specs</b>	Colour Temp	2700/3300/4000K					
	CRI	90+					
	Lumens (Output)	200LM	300LM	450LM	700LM	900LM	1000LM
	Dimmable	Yes					
<b>LED</b>	Type	Epistar					
	Life Span	50,000 Hours					
<b>Design</b>	Dimensions (Inches)	9 x 3.5 x 1"	12 x 3.5 x 1"	18 x 3.5 x 1"	24 x 3.5 x 1"	32 x 3.5 x 1"	40 x 3.5 x 1"
	Dimensions (MM)	22.9 x 8.9 x 2.5mm	30.5 x 8.9 x 2.5mm	45.7 x 8.9 x 2.5mm	61 x 8.9 x 2.5mm	81.3 x 8.9 x 2.5mm	101.6 x 8.9 x 2.5mm
	Lens	Matte white polycarbonate					
	Body	Extruded aluminum housing					
	Finish	BK-Black, BZ-Bronze, SN-Satin Nickel, WH-White					
<b>Warranty</b>		5 years limited					
<b>Approvals</b>		cETLus and Energy Star					

\*YY = Trim Finish (see below)

## PRODUCT CODES

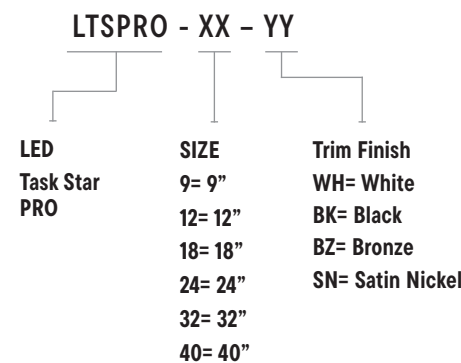

## DIAGRAM

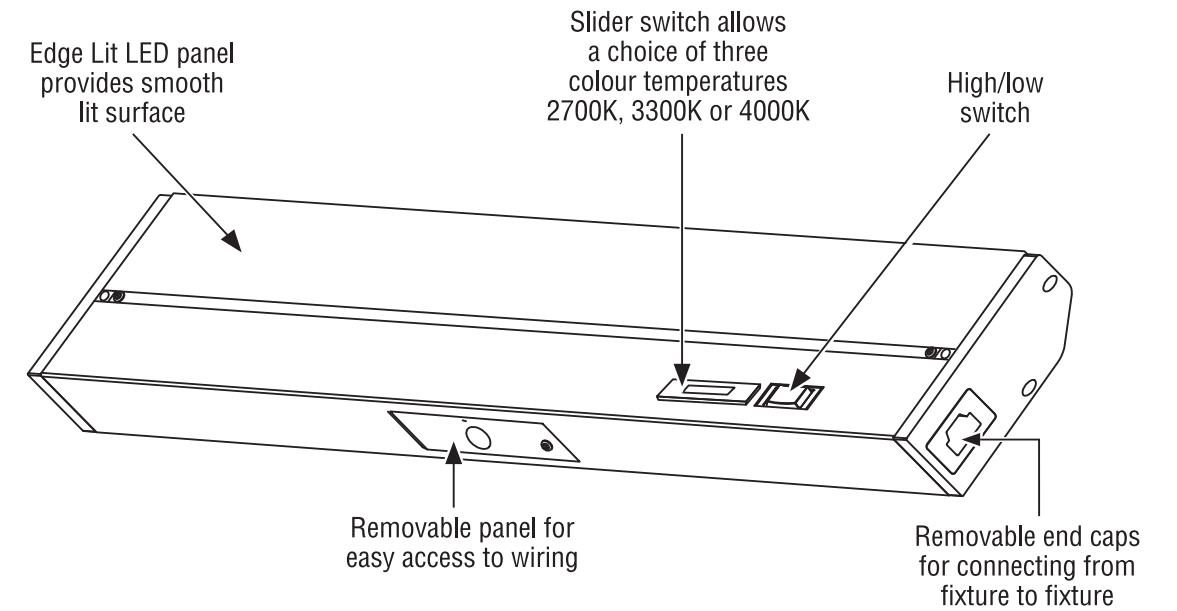

## ACCESSORIES



### LTSPRO-J-12\*

12" jumper cable

### LTSPRO-J-18\*

18" jumper cable

### LTSPRO-J-24\*

24" jumper cable

### LTSPRO-J-32\*

32" jumper cable



### LTSPRO-PC-72\*

72" replacement power cord and plug



### LTSPRO-JB

Hardwire junction box for LTSPRO fixtures - allows for direct wiring installation, eliminating the visible household wire. Add (-BK) at the end of part number for black finish.



### RC-01

3/8" Romex connector

## REPLACEMENT PARTS

### LTSPRO-SW-BK

CCT Slider Switch Cover, Black

### LTSPRO-SW-WH

CCT Slider Switch Cover, White



# LED Edgelit Puck Lights

The Edge Lit Puck Lights are sleek and powerful surface mount lighting fixtures, combining the easy installation with high performance LED's. Featuring strong internal magnets, they can be installed on metal surfaces, without screws or mounting holes.



## FEATURES

- 30,000 hours life
- Edgelit design with smooth light output
- Safe 24V low voltage operation
- Operating temperature: -30°C to 40°C
- Durable die-cast aluminum housing suitable for dry location
- Strong magnet and stamped steel plate for surface mounting
- 72 inch pre-installed lead wire
- 3-year limited warranty

## APPLICATIONS

- Under cabinets
- Over cabinets
- Indirect lighting
- Display cases
- Furniture
- Shelf lighting

## SPECIFICATIONS

Product Code		EPL - SR - WW - XX (ROUND)	EPL - SS - WW - XX (SQUARE)
Electrical	Input Voltage	24V DC	
	Power Consumption	4W	
Specs	Colour Temperature	3000K	
	CRI	90+	
	Lumens	200LM	
	Efficacy (LM/W)	50	
	Dimmable	Yes	
	Beam Angle	24/36/60° (Replacable)	
LED	Type	5630 SMD LEDs	
	Life Span	30,000 Hours	
Design	Dimensions (Inches)	3 x 0.5"	3 x 0.5"
	Dimensions (Millimeters)	76 x 12.7mm	76 x 12.7mm
	Finish	White, Black, Bronze	
	Material	Die-cast aluminum	
	Operating Temperature	-20 to 40°C	
	Approved Location	Indoor	
	Mounting	Surface mount	
Warranty	3 years		
Approvals	cETLus		

## PRODUCT CODE

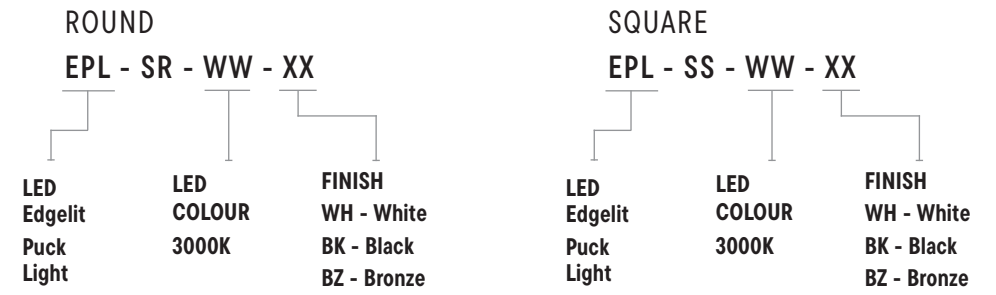

## DIAGRAM

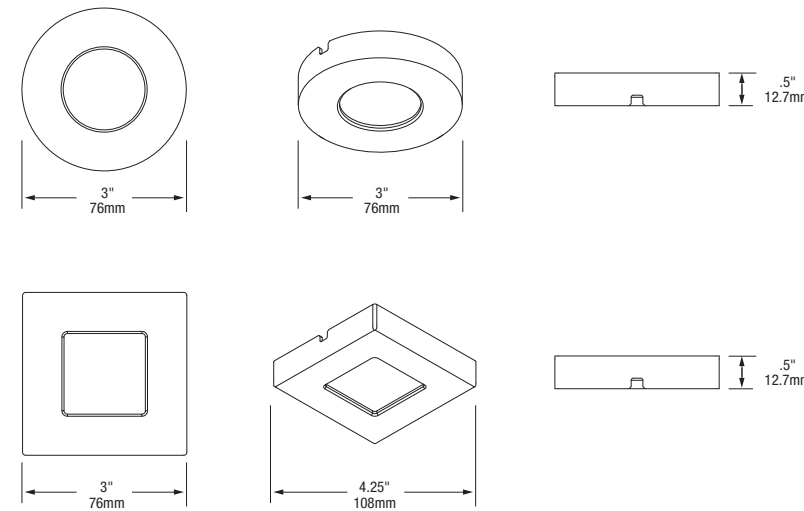

## ACCESSORIES



### LMSII-001

Terminal block and junction box for connection to additional lengths of power cable if needed.

## DIMMABLE DRIVERS

### MLDRE-40-24-DM

Max recommended load 36W or 9 Edge Lit Puck Lights, min 8W or 2 Edge Lit Puck Lights 6.77" x 2.67" x 1.26" (171 x 68 x 32mm)

### MLDRE-96-24-DM

Max recommended load 92W or 23 Edge Lit Puck Lights, min 8W or 2 Edge Lit Puck Lights 6.77" x 2.67" x 1.26" (171 x 68 x 32mm)

## NON-DIMMABLE DRIVERS

### MLDR-120-24

Indoor/Outdoor driver  
Max. recommended load 96W or 24 Edge Lit Puck Lights per single tap, 120W or 30 Edge Lit Puck Lights combined two secondary taps.  
120W hardwire  
Input: 100 - 240V AC  
Output: 24V DC  
10" x 3 3/8" x 3 3/16" (254 x 85.7 x 80.9mm)

### MLDR-20-24JB

Indoor driver  
Max recommended load 16W or 4 Edge Lit Puck Lights  
20W hardwire  
Input: 100 - 240V AC  
Output: 24V DC  
4 1/8" x 4 1/8" x 1 1/2" (104.8 x 104.8 x 38.1mm)

# LED Hard Strip RGB

Designed for simplicity and efficiency, this LED strip provides a wide beam of light in a durable aluminum casing, with sizes to fit various spaces.



## FEATURES

- High-brightness LEDs: 0.5W SMD PLCC-2 for powerful lighting.
- Wide spread: 120° angle for even light distribution.
- 24V DC: Low voltage operation.
- Versatile sizes: 11.8", 19.7", 39.4" for multiple applications.
- Easy connect: Connector for linking two strips

## APPLICATIONS

- Under counter
- Display cases
- Cabinet interiors
- Work stations
- Linear interior decorative lighting

## SPECIFICATIONS

		300mm	500mm	1000mm
<b>Product code</b>	LV-HS-RGB-24T2-X	LV-HS-RGB-24T2-1	LV-HS-RGB-24T2-2	LV-HS-RGB-24T2-3
<b>Electrical</b>	Input Voltage	24V DC		
	Power Consumption	3.6W	6W	12W
<b>Specs</b>	Colour Temperature	RGB		
	Viewing Angle	120°		
<b>LED</b>	Type	SMD PLCC-2		
	Life Span	N/A		
	Qty. per strip	18	30	60
<b>Design</b>	Size (Inches)	11.81 x 0.63 x 0.83"	19.69 x 0.63 x 0.83"	39.37 x 0.63 x 0.83"
	Size (Millimeters)	300 x 16 x 21mm	500 x 16 x 21mm	1000 x 16 x 21mm
	Product Material	N/A		
	Operating Temperature	N/A		
<b>Warranty</b>	N/A			
<b>Approvals</b>	cETLus for indoor use			

## MOUNTING OPTIONS

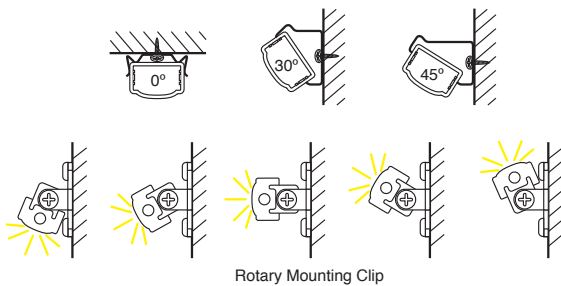

## PRODUCT CODES

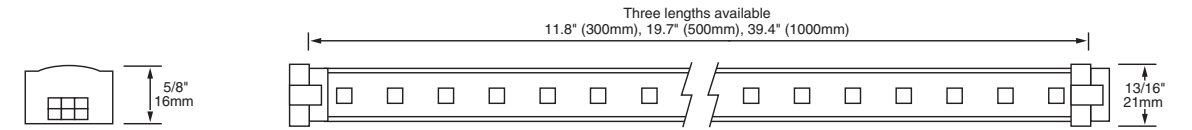
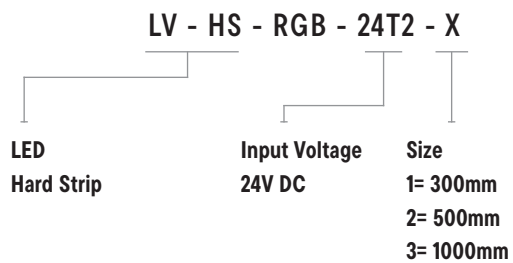

## DIMMABLE DRIVERS

### MLDRE-40-24-DM

Max recommended load 36W, min. 8W LED Hard Strip  
6.77" x 2.67" x 1.26" (171 x 68 x 32mm)

### MLDRE-96-24-DM

Max recommended load 90W, min. 8W LED Hard Strip  
6.77" x 2.67" x 1.26" (171 x 68 x 32mm)

## NON DIMMABLE DRIVERS

### MLDR-120-24

Indoor/Outdoor driver  
Max. recommended load 90W per single tap, 120W combined two secondary taps.  
120W hardwire  
Input: 100 - 240V AC  
Output: 24V DC  
10" x 3 3/8" x 3 3/16" (254 x 85.7 x 80.9mm)

### MLDR-20-24JB

Indoor driver  
Max recommended load 18W  
20W hardwire  
Input: 100 - 240V AC  
Output: 24V DC  
4 1/8" x 4 1/8" x 1 1/2" (104.8 x 104.8 x 38.1mm)

## ACCESSORIES



**LV-HS-PF2-HW**  
39" Power Feed for LED Hard Strip RGB, Bar - Hard wire power supply



**LV-HS-PC2-3**  
3" Power Connector for LED Hard Strip RGB, Bar - Bar



**LV-HS-PC2-12**  
12" Power Connector for LED Hard Strip RGB, Bar - Bar



**LV-HS-PC2-39**  
39" Power Connector for LED Hard Strip RGB, Bar - Bar



**LV-HS-EC**  
End Cap for LED Hard Strip

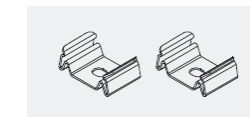

**LV-HS-MC0**  
Mounting clip (2pk)

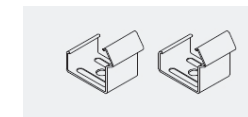

**LV-HS-MC30**  
Mounting clip 30° (2pk)

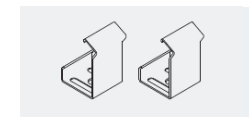

**LV-HS-MC45**  
Mounting clip 45° (2pk)

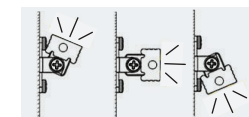

**LV-HS-MCRT**  
Rotary Mounting clip (2pk)



**LN-WIFI-RM**  
4-Zone RGB+CCT Remote



**LN-WIFI-CTRL**  
3 in 1 LED Strip Controller (WiFi + 2G)



**LT-WIFI-AMP**  
WiFi Signal Amplifier for RGB, RGBW, CCT





# Landscape Lighting



# Uplight (Wattage Adjustable)

Engineered for durability and flexibility, this LED Uplight achieves up to 900 lumens of brightness with adjustable wattage, complemented by a choice of three beam spreads.



## FEATURES

- Adjustable wattage control
- High lumen output
- Durable die-cast aluminum
- Versatile beam spread
- Sleek black finish
- Wide voltage compatibility
- Warm light temperature
- Easy installation design
- Weather-resistant coating
- Long-lasting, 15 years warranty

## APPLICATIONS

- Garden lighting
- Facade lighting
- Pathway safety
- Security lighting
- Sign lighting
- Patio ambiance



## SPECIFICATIONS

<b>Product Code</b>	UP-01-12V-BLK	
<b>Electrical</b>	Input Voltage	9-17V AC/DC
	Power Consumption	0-12W (Adjustable)
<b>Specs</b>	Colour Temperature	3000K
	CRI	85
	Lumen Output	900LM Max.
	Efficacy (LM/W)	83
	Dimmable	No, but wattage adjustable
	IP Rating	IP65
	Beam Angle	24/36/60° (Replacable)
<b>LED</b>	Life Span	50,000 Hours
<b>Design</b>	Dimensions (Inches)	6.4 x 6.7 x 2.9"
	Dimensions (Millimeters)	161 x 177 x 73mm
	Finish	Black powder coating
	Material	Die-cast aluminum
	Operating Temperature	-20 to 40°C
	Approved Location	Outdoor
	Mounting	Via Stake
<b>Warranty</b>	15 years	
<b>Approvals</b>	cETLus	

## DIAGRAM

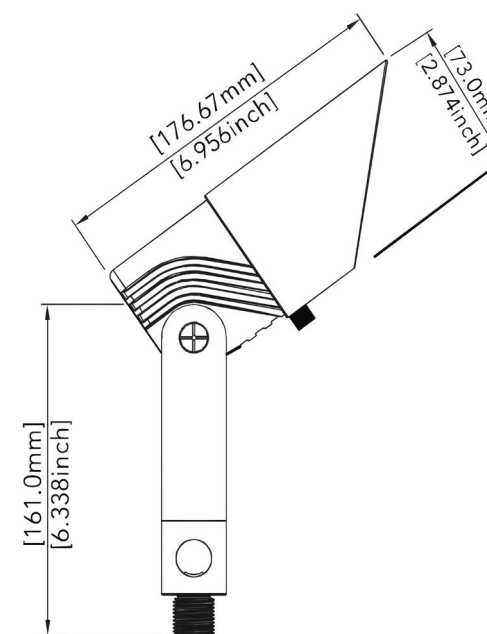

**NOTE:** Comes with a mounting stake to ensure a hassle-free installation.

## ACCESSORIES



**ACC-3R-BLK**  
3 Inch Riser Black



**ACC-7R-BLK**  
7 Inch Riser Black

- 3 inches long
- 1 Male and 1 Female end
- ½ inch NPSM thread
- Cast brass
- Black Finish
- 7 inches long
- 1 Male and 1 Female end
- ½ inch NPSM thread
- Cast brass
- Black Finish



**ACC-12G-2C-BUR**  
Landscape burial wire, 12G, 2C - 500ft spool

**ACC-12G-2C-BUR-XX**  
Landscape burial wire, 12G, 2C - custom cuts

**NOTE:** A transformer is required. See page 108 to 111.

# Uplight (RGBW)

Elevate your ambiance with the RGBW Uplight, capable of shining in a myriad of colors at up to 500 lumens, featuring smart app connectivity for easy adjustments, and built with a robust die-cast aluminum body.



## FEATURES

- Adjustable wattage control
- Multiple RGBW colors
- 24/36/60° beam angles
- Durable aluminum construction
- Smart app control
- WIFI/Bluetooth enabled
- 9-17V AC/DC compatible
- Sleek black finish
- Long-lasting, 15 years warranty

## APPLICATIONS

- Accent lighting
- Path illumination
- Garden highlights
- Security lights
- Art spotlights
- Event lighting



## SPECIFICATIONS

<b>Product Code</b>	UP-02-12V-BLK	
<b>Electrical</b>	Input Voltage	9-17V AC/DC
	Power Consumption	0-8W (Adjustable)
<b>Specs</b>	Colour Temperature	RGB
	CRI	85
	Lumen Output	500LM Max.
	Efficacy (LM/W)	70
	Dimmable	No, but wattage adjustable
	IP Rating	IP65
	Beam Angle	24/36/60° (Replacable)
<b>LED</b>	Life Span	50,000 Hours
<b>Design</b>	Dimensions (Inches)	6.4 x 6.7 x 2.9"
	Dimensions (Millimeters)	161 x 177 x 73mm
	Finish	Black powder coating
	Material	Die-cast aluminum
	Operating Temperature	-20 to 40°C
	Approved Location	Outdoor
	Mounting	Via Stake
<b>Warranty</b>	15 years	
<b>Approvals</b>	cETLus	

## DIAGRAM

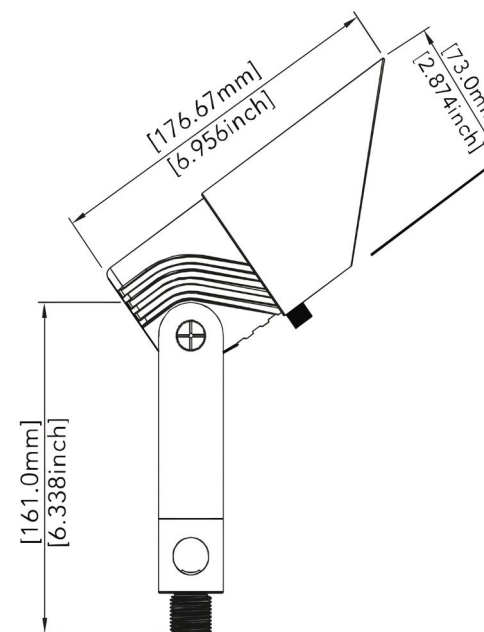

**NOTE:** Comes with a mounting stake to ensure a hassle-free installation.

## ACCESSORIES



**ACC-3R-BLK**  
3 Inch Riser Black



**ACC-7R-BLK**  
7 Inch Riser Black

- 3 inches long
- 1 Male and 1 Female end
- ½ inch NPSM thread
- Cast brass
- Black Finish
- 7 inches long
- 1 Male and 1 Female end
- ½ inch NPSM thread
- Cast brass
- Black Finish



**ACC-12G-2C-BUR**

Landscape burial wire, 12G, 2C - 500ft spool

**ACC-12G-2C-BUR-XX**

Landscape burial wire, 12G, 2C - custom cuts

**NOTE:** A transformer is required. See page 108 to 111.

# 12V Mini Flood Light

This compact yet powerful 12V Mini Flood light, with a customizable wattage between 1 and 5 watts, provides a luminous output of 80-400 lumens, encased in a durable cast brass housing.



## FEATURES

- Adjustable wattage control
- 80-400 lumen output
- Integrated 12V LED
- Cast brass housing
- 3000K warm light
- Black or bronze finish
- Spike mounting option
- Wide beam angle
- Long-lasting, 15 years warranty
- Smart control compatibility

## APPLICATIONS

- Path illumination
- Outdoor accents
- Security lighting
- Architectural highlights
- Event ambiance
- Patio glow



SPECIFICATIONS		
<b>Product Code</b>	FL-01-12V-BLK	
<b>Electrical</b>	<b>Input Voltage</b>	12V AC/DC
	<b>Power Consumption</b>	1-5W
<b>Specs</b>	<b>Colour Temperature</b>	2700K, 3000K
	<b>CRI</b>	85
	<b>Lumen Output</b>	400LM
	<b>Efficacy (LM/W)</b>	80
	<b>Dimmable</b>	No, but wattage adjustable
	<b>Beam Angle</b>	120°
<b>LED</b>	<b>Life Span</b>	50,000 Hours
<b>Design</b>	<b>Dimensions (Inches)</b>	4 x 3.9 x 2.5"
	<b>Dimensions (Millimeters)</b>	101.5 x 100 x 63mm
	<b>Finish</b>	Black
	<b>Material</b>	Solid Brass Casting
	<b>Operating Temperature</b>	-20 to 40°C
	<b>Approved Location</b>	Outdoor
	<b>Mounting</b>	Via Stake
<b>Warranty</b>	15 years	
<b>Approvals</b>	cETLus	

## DIAGRAM

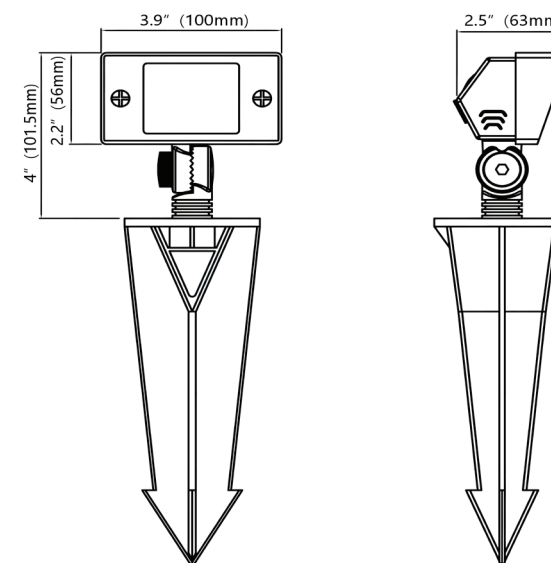

**NOTE:** Comes with a mounting stake to ensure a hassle-free installation.

## ACCESSORIES



**ACC-3R-BLK**  
3 Inch Riser Black

- 3 inches long
- 1 Male and 1 Female end
- ½ inch NPSM thread
- Cast brass
- Black Finish



**ACC-7R-BLK**  
7 Inch Riser Black

- 7 inches long
- 1 Male and 1 Female end
- ½ inch NPSM thread
- Cast brass
- Black Finish



**ACC-12G-2C-BUR**

Landscape burial wire, 12G, 2C - 500ft spool

**ACC-12G-2C-BUR-XX**

Landscape burial wire, 12G, 2C - custom cuts

**NOTE:** A transformer is required. See page 108 to 111.



# 120V Mini Flood Light (CCT)

Achieve perfect outdoor lighting for any occasion with CCT Adjust Mini Flood Lights, featuring adjustable CCTs for versatile illumination. Their compact size and high efficiency make them a smart choice for diverse landscape applications.

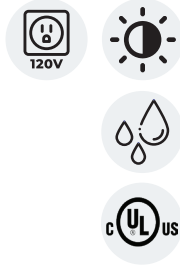

## FEATURES

- Adjustable CCT (3000K/4000K/5000K)
- High lumen output
- Easy installation
- Wide beam angle
- Long lifespan (50,000 hours)
- Instant start, no flicker
- Wattage options (15W, 30W, 50W)
- Wet location rated
- 5 years warranty

## APPLICATIONS

- Facade accenting
- Garden highlights
- Outdoor art display
- Parking areas
- Entryway illumination
- Commercial exteriors

## SPECIFICATIONS

Product Code	FL-15-CT	FL-30-CT	FL-50-CT	
<b>Electrical</b>	Input Voltage	100 -277V AC		
	Power Consumption	15W	30W	50W
<b>Specs</b>	Colour Temperature	3000/4000/5000K		
	CRI	80+		
	Lumen Output	3000K: 1725-1950LM	3000K: 3450-3900LM	3000K: 5750-6500LM
		4000K: 2025-2250LM	4000K: 4050-4500LM	4000K: 6750-7500LM
		5000K: 1875-2100LM	5000K: 3750-4200LM	5000K: 6250-7000LM
	Efficacy (LM/W)	Up to 150		
	Dimmable	No, but wattage adjustable		
Beam Angle	150° x 120° (7H6V)			
<b>LED</b>	Type	SMD3030 (1W)		
	Life Span	50,000 Hours		
<b>Design</b>	Dimensions (Inches)	6 5/8 x 8 x 1 3/4"	6 5/8 x 8 x 1 3/4"	7 5/16 x 9 7/16 x 1 15/16"
	Dimensions (Millimeters)	168.3 x 204 x 43.7 mm	168.3 x 204 x 43.7 mm	201 x 239 x 49 mm
	Finish	Black		
	Material	N/A		
	Operating Temperature	-20 to 50°C		
	Approved Location	Wet		
<b>Warranty</b>	5 years			
<b>Approvals</b>	cULus listed for wet locations			



## DIAGRAM

### 15W and 30W

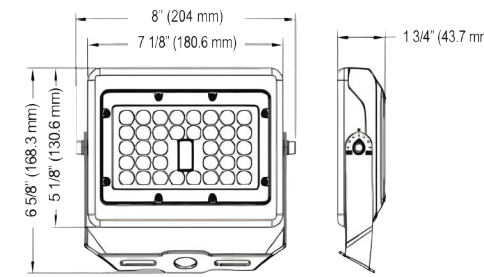

### 50W

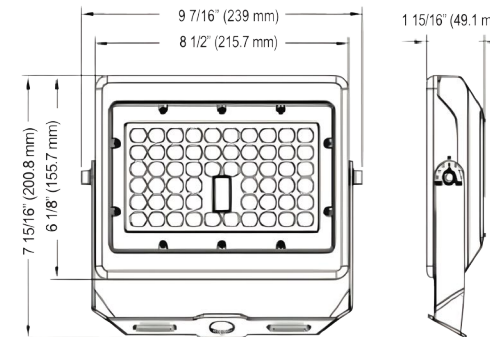

## MOUNTING ACCESSORIES

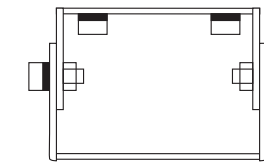

**FL-TR**  
Trunnion mount bracket  
To use for wall and ground mount



**FL-Y-15/30/50**  
Yoke mount bracket  
To use for wall and ground mount



**FL-SH-15/30/50**  
Glare shield

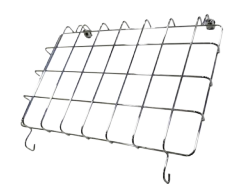

**FL-WG-15/30/50**  
Wire guard

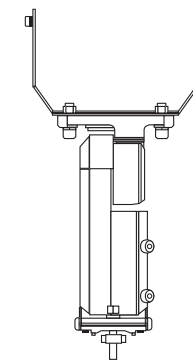

**FL-ADM-15/30/50**  
Universal mount bracket  
For use on poles

# Modern Pathway Light

Designed for the modern landscape, this L-shaped Pathway Light offers an adjustable light output of 80-240 lumens and a warm 3000K temperature, creating a welcoming atmosphere for any outdoor setting.



## FEATURES

- L-shaped contemporary design
- Adjustable 1-3W wattage
- Integrated 9-17V LED
- Warm 3000K temperature
- Durable cast aluminum
- Frosted lens diffusion
- Easy spike mounting
- 18/2 wire pigtail
- Full/half light mode
- Serviceable LED module
- Wet location listed
- Long-lasting, 15 years warranty

## APPLICATIONS

- Pathway illumination
- Garden lighting
- Outdoor accent
- Entryway paths
- Architectural highlights
- Safety lighting



SPECIFICATIONS		
<b>Product Code</b>	WF-01-12V-BLK	
<b>Electrical</b>	Input Voltage	9-17V AC/DC
	Power Consumption	1-3W
<b>Specs</b>	Colour Temperature	3000K
	CRI	85
	Lumen Output	80-240LM
	Efficacy (LM/W)	77
	Dimmable	No, but wattage adjustable
	IP Rating	IP65
	Beam Angle	150° (Replacable)
<b>LED</b>	Life Span	50,000 Hours
<b>Design</b>	Dimensions (Inches)	21 1/4 x 6 1/8 x 7/8"
	Dimensions (Millimeters)	540.2 x 154 x 22mm
	Finish	Black
	Material	Aluminum
	Operating Temperature	-40 to 40°C
	Approved Location	Outdoor
	Mounting	Via Stake
<b>Warranty</b>	15 years	
<b>Approvals</b>	cETLus	

## DIAGRAM



NOTE: Comes with a mounting stake to ensure a hassle-free installation.

## ACCESSORIES



### ACC-12G-2C-BUR

Landscape burial wire, 12G, 2C - 500ft spool

### ACC-12G-2C-BUR-XX

Landscape burial wire, 12G, 2C - custom cuts

NOTE: A transformer is required. See page 108 to 111.

# Round Tea-Hat Pathway Light

The Round Tea-Hat Light redefines pathway illumination with its unique round hat design, offering an energy-efficient solution to brighten outdoor settings, backed by a durable construction..



## FEATURES

- Wattage adjustable
- Broad lumen range
- Low-voltage efficiency
- Warm color temperature
- Durable cast aluminum construction
- Hastle-free installation
- Spike-mounted for stability
- Sleek black finish
- Easy-connect 18/2 wire pigtail
- Long-lasting, 15 years warranty

## APPLICATIONS

- Pathway lighting
- Landscape accent
- Garden paths
- Entrance lighting
- Recreational areas



SPECIFICATIONS		
<b>Product Code</b>	WF-03-12V-BLK	
<b>Electrical</b>	Input Voltage	9-17V AC/DC
	Power Consumption	1-3W
<b>Specs</b>	Colour Temperature	3000K
	CRI	85
	Lumen Output	80-240LM
	Efficacy (LM/W)	80
	Dimmable	No, but wattage adjustable
	IP Rating	IP65
	Beam Angle	150°
<b>LED</b>	Life Span	50,000 Hours
<b>Design</b>	Dimensions (Inches)	23 1/2 x 3 5/8 x 1"
	Dimensions (Millimeters)	597 x 93 x 26mm
	Finish	Black
	Material	Aluminum
	Operating Temperature	-40 to 40°C
	Approved Location	Outdoor
	Mounting	Via Stake
<b>Warranty</b>	15 years	
<b>Approvals</b>	cETLus	

## DIAGRAM

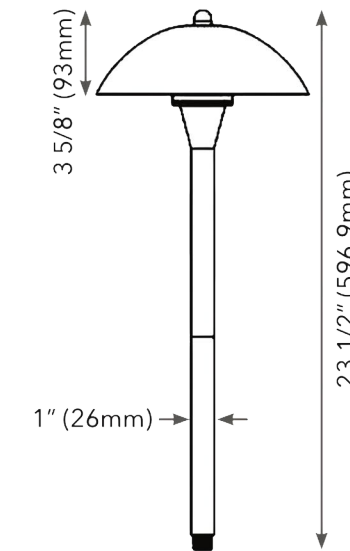

**NOTE:** Comes with a mounting stake to ensure a hassle-free installation.

## ACCESSORIES



### ACC-12G-2C-BUR

Landscape burial wire, 12G, 2C - 500ft spool

### ACC-12G-2C-BUR-XX

Landscape burial wire, 12G, 2C - custom cuts

**NOTE:** A transformer is required. See page 108 to 111.



# Heavy Duty Classic Pathway Light

Upgrade outdoor spaces with the Classic Top Pathway Light, blending traditional aesthetics with energy-saving LED in a durable brass fixture.



## FEATURES

- Heavy cast brass construction
- Integrated 3000K LED chip
- 12V energy-saving operation
- Spike mounting simplicity
- Reliable 18/2 wire connection
- Classic design, modern tech
- Easy integration into landscapes
- Weather-resistant for outdoor use
- Long-lasting, 15 years warranty

## APPLICATIONS

- Pathway lighting
- Garden enhancement
- Architectural accents
- Decorative outdoor
- Entrance highlighting
- Driveway borders



SPECIFICATIONS		
<b>Product Code</b>	WF-04-12V-BLK	
<b>Electrical</b>	<b>Input Voltage</b>	12V AC/DC
	<b>Power Consumption</b>	5W
<b>Specs</b>	<b>Colour Temperature</b>	2700K, 3000K
	<b>CRI</b>	85
	<b>Lumen Output</b>	400LM
	<b>Efficacy (LM/W)</b>	80
	<b>Dimmable</b>	No, but wattage adjustable
	<b>IP Rating</b>	IP65
	<b>Beam Angle</b>	150°
<b>LED</b>	<b>Life Span</b>	50,000 Hours
<b>Design</b>	<b>Dimensions (Inches)</b>	14.96 x 6.6"
	<b>Dimensions (Millimeters)</b>	380 x 168mm
	<b>Finish</b>	Black
	<b>Material</b>	Die-cast brass
	<b>Operating Temperature</b>	-20 to 40°C
	<b>Approved Location</b>	Outdoor
	<b>Mounting</b>	Via Stake
<b>Warranty</b>	15 years	
<b>Approvals</b>	cETLus	

## DIAGRAM



**NOTE:** Comes with a mounting stake to ensure a hassle-free installation.

## ACCESSORIES



### ACC-12G-2C-BUR

Landscape burial wire, 12G, 2C - 500ft spool

### ACC-12G-2C-BUR-XX

Landscape burial wire, 12G, 2C - custom cuts

**NOTE:** A transformer is required. See page 108 to 111.

# Commercial Bollards

Engineered for outdoor resilience, bollard lights provide efficient, low-glare lighting, perfect for enhancing visibility and ambiance in landscape areas.



## FEATURES

- 3 base heights and 2 head options
- Input voltage range: 120-347V AC
- High efficiency: >92% power efficiency
- Dimmable: 0-10V dimming
- Surge protection: 4KV/6KV
- Tunable CCT: 3000/4000/5000K
- Wide beam angle: 110°×105°
- Durable build: IP65 rating, die-cast aluminum housing
- Long lifespan: >50,000 hours
- Certifications: ETL/DLC 5.1 premium
- Warranty: 5 years

## APPLICATIONS

- Pathways and walkways
- Gardens and flower beds
- Driveways and entrances
- Outdoor seating areas
- Pool decks and water features
- Perimeter and boundary lighting



## SPECIFICATIONS

Product Code	Head	WF-CB-MV-H-RMW (Round)		WF-CB-MV-H-FMW (Flat)
	Body	WF-CB-MV-BD1050	WF-CB-MV-BD670	WF-CB-MV-BD400
Electrical	Input Voltage	120-347V AC		
	Power Consumption	25/20/15/8W		
Specs	Colour Temperature	3000/4000/5000K (TUNABLE)		
	CRI	70+		
	Lumen Output	3,125/2,500/1,875/1,000LM		
	Efficacy	125 LM/W		
	Dimmable	0-10V		
	Beam Angle	110° × 105°		
LED	Type	3030		
	Life Span	>50,000 Hours		
Design	Dimensions (Inches)	R: H= 41.34"   F: H = 39.49"	R: H= 26.4"   F: H = 24.53"	R: H= 15.75"   F: H = 13.90"
		W= 5.91"		
	Dimensions (Millimeters)	R: H= 1050mm   F: H = 1003mm	R: H= 670mm   F: H = 623mm	R: H= 400mm   F: H = 353mm
		W= 150mm		
	Finish	Black		
	Material	Die-cast Aluminum		
Operating Temperature	-40°F to 104°F (-40°C to 40°C)			
Approved Location	Outdoor			
Mounting	Via base, refer to instructions for details			
Warranty	5 years			

## DIAGRAM

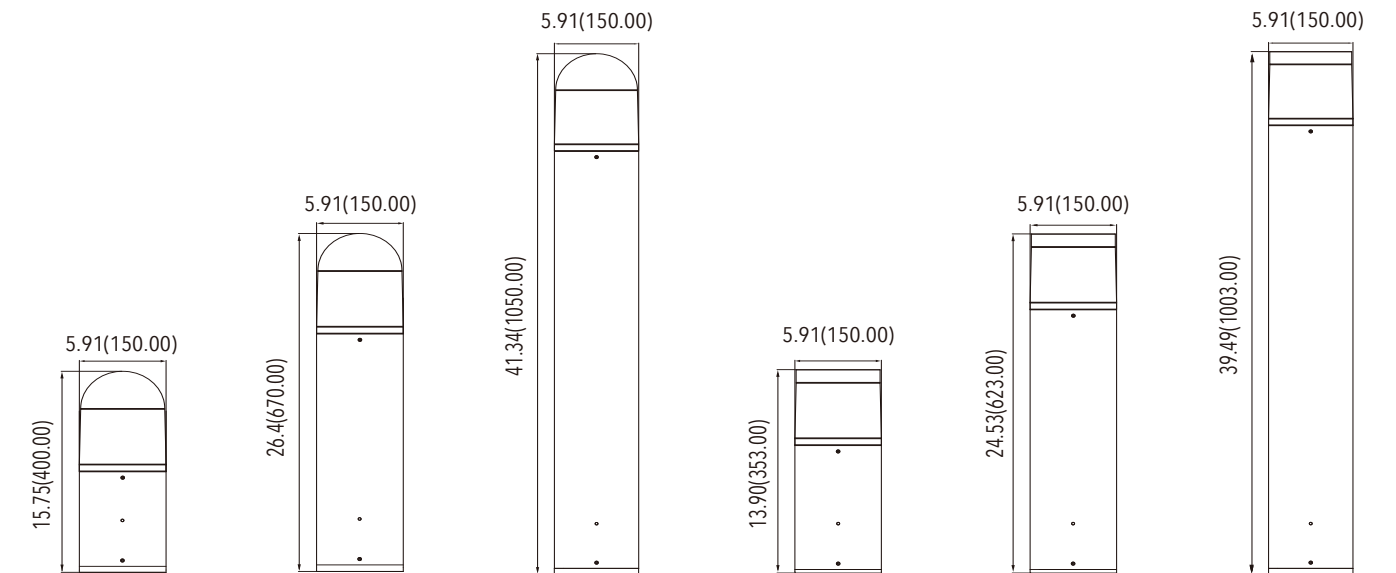

## ACCESSORIES



**WF-CB-SP**  
Surge Protector

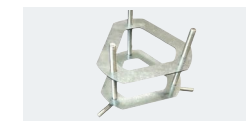

**WF-CB-MT**  
Anchor Bolt Carrier

NOTE: A transformer is required. See page 108 to 111.

# Surface Mount Deck/Riser Light



Create a welcoming atmosphere on decks and pathways with a light that adjusts to your preferences; easy installation for immediate impact.

## FEATURES

- Adjustable wattage from 1W to 3W with a dip switch
- 70° beam spread
- 85 CRI
- Warm glow (3000K)
- Sleek black finish
- Quick setup with 18/2 wire pigtail
- Cast aluminum housing
- Wet location listed
- Long-lasting, 15 years warranty

## APPLICATIONS

- Pathway illumination
- Deck lighting
- Step safety
- Garden ambiance
- Entrance highlighting
- Fence lighting



SPECIFICATIONS		
<b>Product Code</b>	WF-02-12V-BLK	
<b>Electrical</b>	Input Voltage	12/24V AC/DC
	Power Consumption	0-3W (Adjustable)
<b>Specs</b>	Colour Temperature	3000K
	CRI	85
	Lumen Output	60-180LM
	Efficacy (LM/W)	60
	Dimmable	No, but wattage adjustable
	IP Rating	IP65
	Beam Angle	70°
<b>LED</b>	Life Span	50,000 Hours
<b>Design</b>	Dimensions (Inches)	4 x 2 5/8"
	Dimensions (Millimeters)	101.6 x 66.67 mm
	Finish	Black
	Material	Aluminum
	Operating Temperature	-40 to 40°C
	Approved Location	Outdoor
	Mounting	Via screws to wall
<b>Warranty</b>	15 years	
<b>Approvals</b>	cETLus	

## DIAGRAM

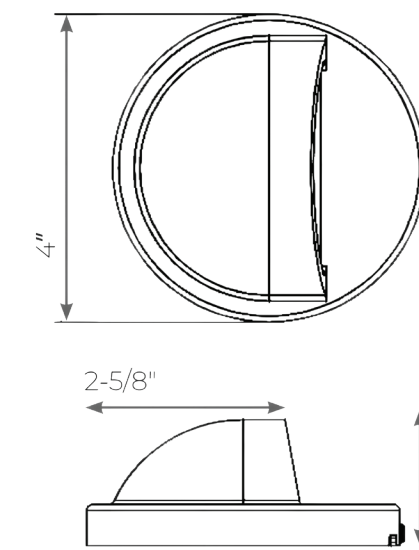

## ACCESSORIES



**ACC-12G-2C-BUR**  
Landscape burial wire, 12G, 2C - 500ft spool

**ACC-12G-2C-BUR-XX**  
Landscape burial wire, 12G, 2C - custom cuts



# Outdoor Wall Sconce

A contemporary style wall sconce suitable for interior and exterior use. Available in three finishes and three interchangeable covers to suit a variety of applications,



## FEATURES

- Housing: Rugged aluminum construction
- 120V - 277V AC input voltage
- Lumen output 1300LM
- CRI 80+
- LED life: 50,000 hours
- Powder coated finish
- 120° beam angle
- ADA compliant
- Finishes: Brown, Black and Silver
- Three interchangeable covers: Wave, Wing and Scoop
- cULus listed for wet locations

## APPLICATIONS

- Exterior residential & commercial
- Entrance ways
- Hallway lighting
- Patio & deck Lights
- Hotel hallways & restaurants
- Stairways & lobbies

3 COVER OPTIONS (Sold separately)

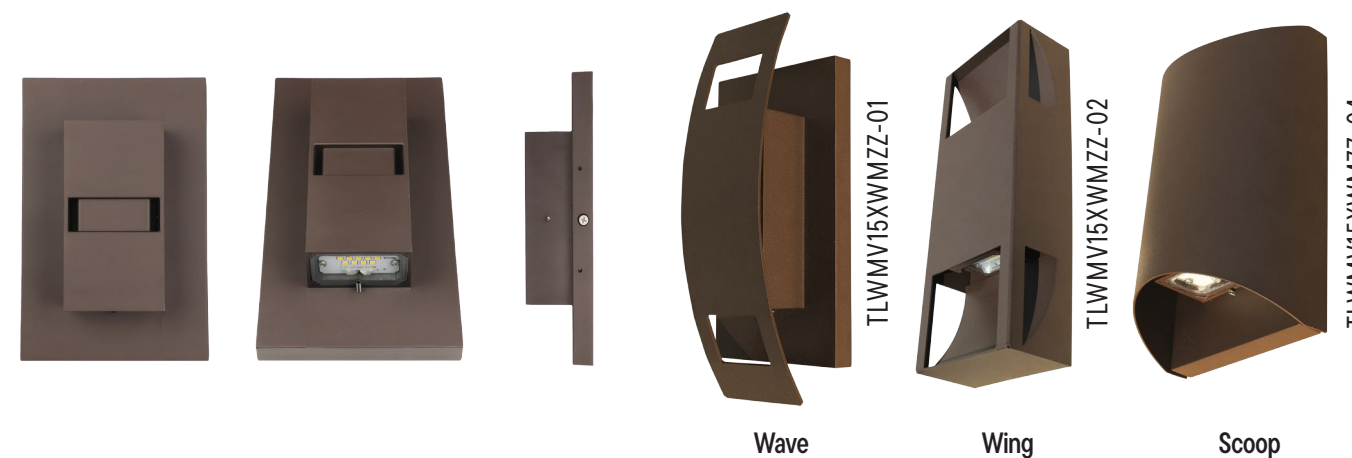

## PRODUCT CODES

## DIAGRAM

SPECIFICATIONS		
<b>Product Code</b>	TLWMV15XWMZZ	
<b>Electrical</b>	Input Voltage	120V - 277V AC
	Power Consumption	15W
<b>Specs</b>	Colour Temperature	3000/4000K
	CRI	80+
	Lumen Output	1300LM
	Efficacy (LM/W)	60
	Dimmable	No
	Beam Angle	120°
<b>LED</b>	Type	LUMILED 3030
	Life Span	>50,000 Hours
<b>Design</b>	Dimensions (Inches)	8 x 4 3/8 x 2 1/8"
	Dimensions (Millimeters)	203 x 111 x 54mm
	Finish	Powder coated finish
	Material	Aluminum
	Operating Temperature	-20 to +40°C
	Approved Location	Outdoor
	Mounting	Wall
<b>Warranty</b>	5 years	
<b>Approvals</b>	cULus listed for wet locations	

## TLWMV15XWMZZ

- LED Outdoor Sconce**
- COLOUR OF LED**  
3 - 3000K  
4 - 4000K
- FINISH**  
BR - Brown  
BK - Black  
SV - Silver

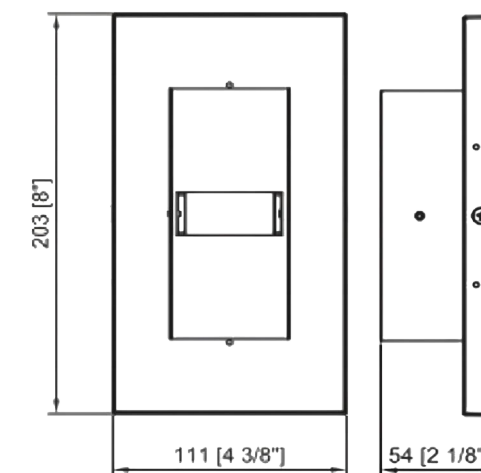

## DIAGRAMS (COVERS)

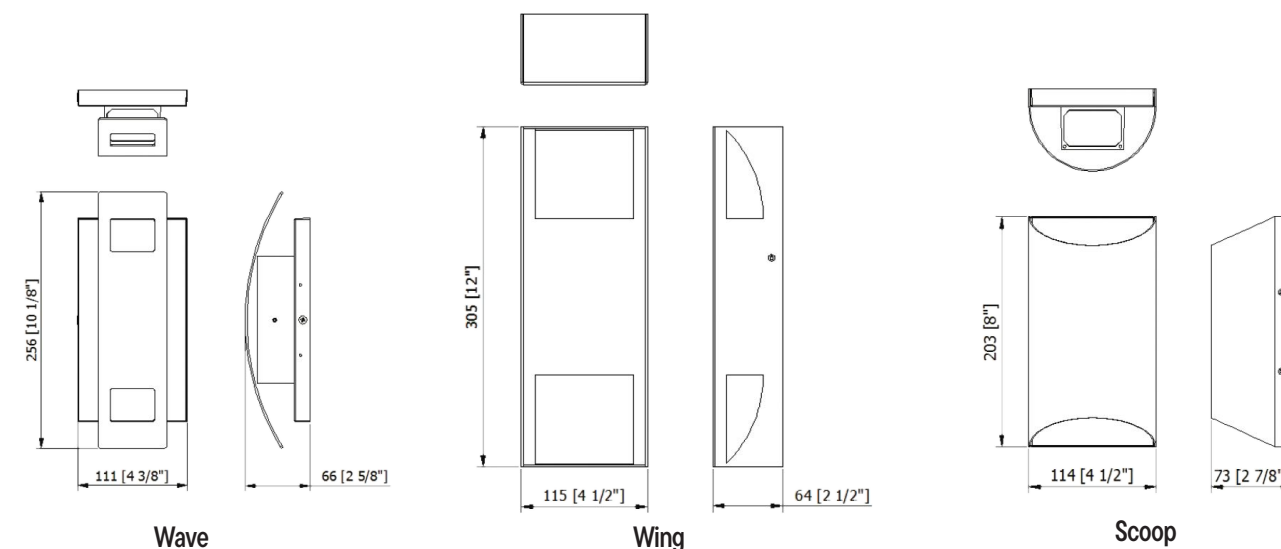

# Brick Star (Gen II)

LED Brick Star enhances stairs, aisles, and paths with attractive, cost-effective lighting, designed to fit standard brick sizes for easy integration and optimal performances,



## FEATURES

- Long-lasting 40,000-hour LED
- Ultra-low energy use: 5.2 watts
- High color accuracy: CRI 80+
- Lens: Frosted tempered glass
- Standard 120VAC input
- Supports up to 150 units per tap
- Durable die-cast aluminum build
- Available in fluorocarbon can with stainless steel louvre cover
- Standard brick size fit
- Compatible with TRIAC dimmers
- 3 years warranty

## APPLICATIONS

- Brick walls
- Exterior steps
- Interior steps
- Aisles
- Halls
- Paths
- Patio lighting
- Entry lighting
- Ceilings
- Showers

## SPECIFICATIONS

SPECIFICATIONS		LEDBS-II-WH-X-YY
<b>Product Code</b>	LEDBS-II-WH-X-YY	
<b>Electrical</b>	Input Voltage	120V AC
	Power Consumption	5.2W
<b>Specs</b>	Colour Temperature	3000K
	CRI	80+
	Lumen Output	468LM
	Efficacy (LM/W)	90
	Dimmable	Yes, with TRIAC dimming systems
	Beam Angle	N/A
<b>LED</b>	Life Span	>40,000 Hours
<b>Design</b>	Dimensions (Inches)	3 x 9"
	Dimensions (Millimeters)	76.2 x 228.6mm
	Can Finish	Powder Coated White or Fluorocarbon Lacquer (Stainless Steel)
	Cover Finish	White, Black, Bronze, Aluminum or Stainless Steel finish only available in Louvre cover
	Lens	Frosted tempered glass
	Max Single Run Length	Can be daisy chained up to 150 fixtures per 15A circuit
	Approved Location	Wet and IC locations, concrete pour, shower
<b>Mounting</b>	Wall, ceiling	
<b>Warranty</b>	3 years	
<b>Approvals</b>	cETLus listed for wall, ceiling, wet and IC locations	

**NOTE:** When installing LED Brick Star in harsh environments (such as limestone, salted areas, coastal environments, etc.) please use the stainless steel version to avoid the risk of corrosion to the body of the fixture.

## PRODUCT CODES

### LEDBS-II-WH-X-YY

LED Brick Star	COLOUR OF LED	COVER	COVER FINISH
	3000K	P - Prism	WH - White
		S - Scoop	BK - Black
		L - Louvre	BZ - Bronze
			AL - Aluminum
			SS - Stainless Steel

## REPLACEMENT KIT

### LBR-II-KIT

- NOTE: Stainless Steel finish available in Louvre cover only.
- Concrete cap for concrete pour installations.
- NOTE: For outdoor installations, a 1/2" liquid tight strain relief is recommended.

## CONCRETE CAP

### BL-CC

## DIAGRAM

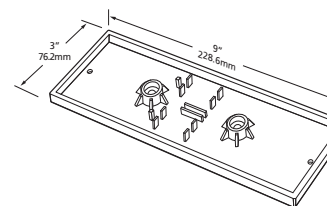
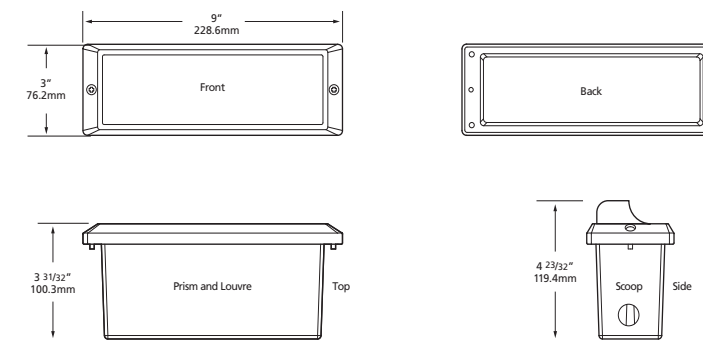
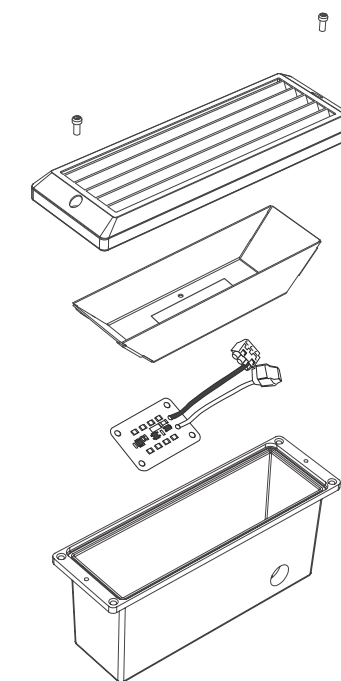

## Concrete Cap (for concrete pour installations)

- Product Code: **BL-CC**
- **IMPORTANT:** It is recommended that you use Magic Lite / NSL's Concrete Cap for concrete pour installations. These caps assist in providing a proper reveal for flush mount of fixture cover after concrete is dry.

# Step Star (Gen II)

LED Step Star offers durable, energy-efficient lighting for stairs and pathways, suitable for both indoor and outdoor use, with a robust cast aluminum build ideal for concrete installations.



## FEATURES

- 40,000-hour LED lifespan
- Ultra-low energy use: 5.2 watts
- Color accuracy with CRI 80+
- Lens: Frosted tempered glass
- Supports 120VAC power input
- Up to 150 units per 120VAC circuit
- Durable die-cast aluminum enclosure
- Versatile indoor/outdoor certification (cETLus)
- Compatible with TRIAC dimmers
- 3 years warranty

## APPLICATIONS

- Interior stairs
- Exterior stairs
- Aisles
- Hallways
- Paths
- Public areas
- Emergency lighting
- Theaters
- Patios
- Decks

SPECIFICATIONS		
<b>Product Code</b>	LEDSST-II-WH-X-YY	
<b>Electrical</b>	Input Voltage	120V AC
	Power Consumption	5.2W
<b>Specs</b>	Colour Temperature	3000K
	CRI	80+
	Lumen Output	468LM
	Efficacy (LM/W)	90
	Dimmable	Yes, with TRIAC dimmable systems
	Beam Angle	N/A
<b>LED</b>	Life Span	>40,000 Hours
<b>Design</b>	Dimensions (Inches)	4 5/8 x 7 1/2"
	Dimensions (Millimeters)	117.5 x 190.5mm
	Can Finish	Powder Coated White
	Cover Finish	White, Black, Bronze, and Aluminum
	Lens	Can be daisy chained up to 150 fixtures per 15A circuit
	Approved Location	Wet and IC locations
	Mounting	Wall, ceiling
<b>Warranty</b>	3 years	
<b>Approvals</b>	cETLus listed for wall, ceiling, wet and IC locations	

Wiring Options: 20V AC hardwire – can be daisy chained up to 150 fixtures per 15A circuit.

## PRODUCT CODES

LEDSST-II-WH-X-YY

LED	COLOUR OF LED	COVER	COVER FINISH
Step Star	3000K	P - Prism	WH - White
Gen II		S - Scoop	BK - Black
		L - Louvre	BZ - Bronze
			AL - Aluminum

## REPLACEMENT KIT

LST-II-KIT

- Concrete cap for concrete pour installations.
- NOTE: For outdoor installations, a 1/2" liquid tight strain relief is recommended.

## CONCRETE CAP

SL-CC

## DIAGRAM

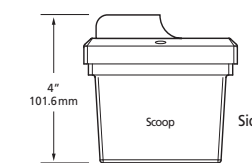
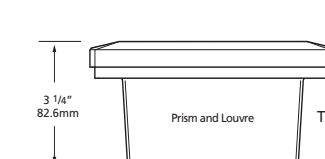
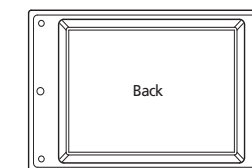
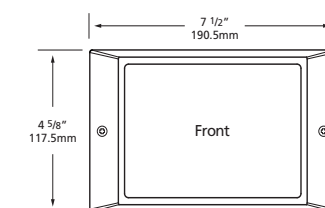
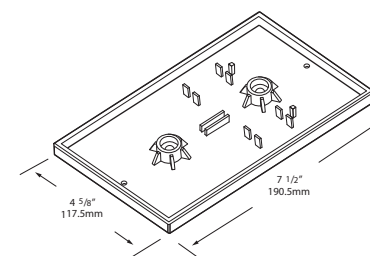
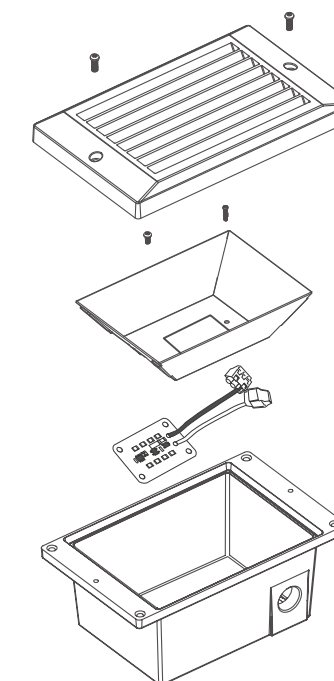

## Concrete Cap (for concrete pour installations)

- Product Code: **BL-CC**
- IMPORTANT: It is recommended that you use Magic Lite / NSL's Concrete Cap for concrete pour installations. These caps assist in providing a proper reveal for flush mount of fixture cover after concrete is dry..



# Switch Star

LED Switch Star is ideal for both indoor and outdoor settings, offering an excellent solution for security or exit lighting. This fixture connects directly to 120V without the need for remote drivers, simplifying installation.



## FEATURES

- 1.4W power consumption
- Mounts on 2" x 4" boxes
- Outdoor/indoor ready
- Louvre/scoop/prism covers
- Horizontal/vertical mounting
- 3 color choices
- Dimmable functionality
- 40,000-hour LED lifespan
- cETLus safety certified
- 3 years warranty

## APPLICATIONS

- Hallways, stairways
- Night light
- Decks, patios
- Garages, elevators
- Commercial/residential exteriors

SPECIFICATIONS		
Product Code	LED-SW-X-Y	
Electrical	Input Voltage	120V AC, .012A
	Power Consumption	1.4W
Specs	Colour Temperature	2700K or Amber
	CRI	80+
	Lumen Output	468LM
	Efficacy (LM/W)	57
	Dimmable	No
	Beam Angle	120°
LED	Type	AC LED
	Life Span	40,000 Hours to 70% Lumen output
Design	Dimensions (Inches)	5.07 x 3.03"
	Dimensions (Millimeters)	129 x 77mm
	Finish	White, Light Almond, Brown Wood Grain
	Material	Polycarbonate (5VA flame rated, F1 UV rated) & Glass
	Operating Temperature	-30°C to 60°C
	Approved Location	Indoor/Outdoor
	Mounting	Via screws
Warranty	3 years	
Approvals	cETLus listed	

## PRODUCT CODES

### LED-SW-X-Y

LED	COVER	COLOUR
Switch	P - Prism	WH - White
Star	S - Scoop	LA - Light Almond
	L - Louvre	BWG - Brown Wood Grain

- Note: Add (-AM) on the part number for Amber LED fixture
- Scoop and Louvre covers are supplied in both horizontal and vertical.

### LED-SW-X-Y-COV

LED	COVER	COLOUR	REPLACEMENT COVER
Switch	P - Prism	WH - White	
Star	S - Scoop	LA - Light Almond	
	L - Louvre	BWG - Brown Wood Grain	



## COVER DIMENSIONS

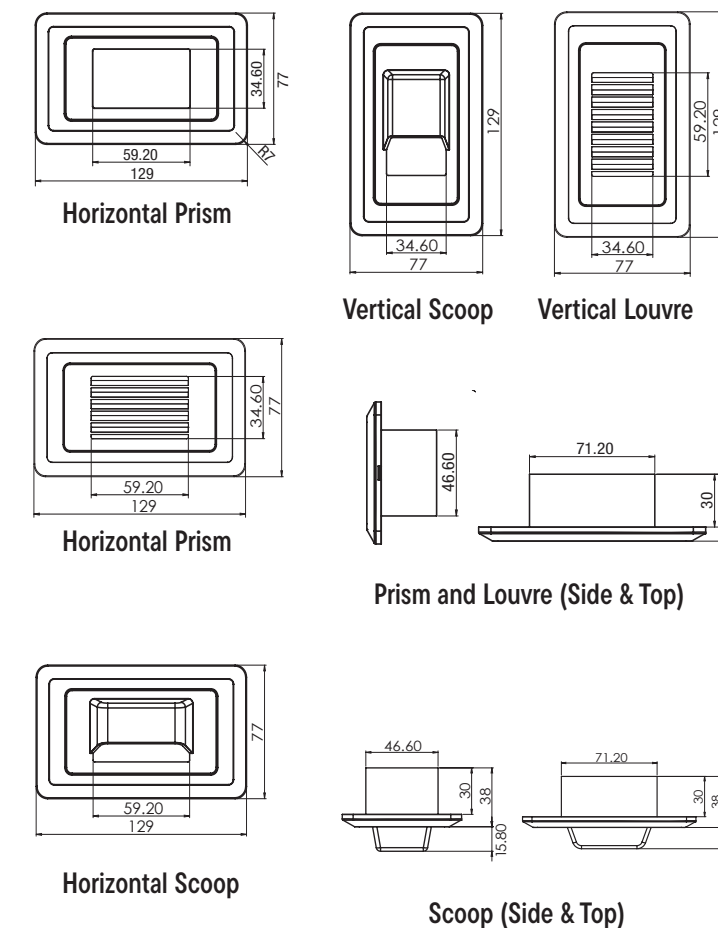

## COVER STYLES

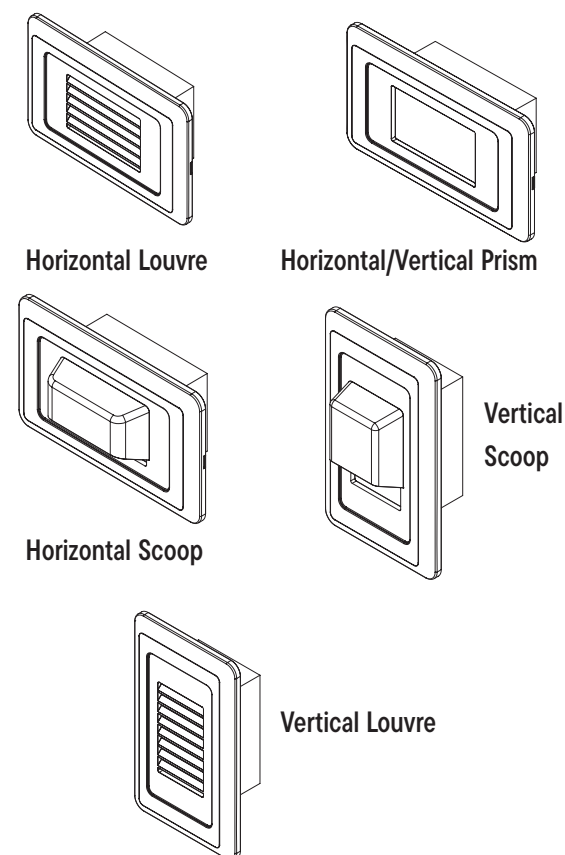

# Disc Light

Versatile and robust, the LED Disc Light offers powerful illumination for both public and residential areas, whether indoors or outdoors. Durable and certified for wet conditions, it's great for enhancing decks, driveways, and patios with simple concrete pour setup.



## FEATURES

- Fully dimmable with dimmable power supply (sold separately)
- 50,000-Hour LED life
- Low power consumption: 3 watts per fixture
- Safe 12 volt, Class 2 power supply (not included)
- Up to 30 fixtures per power supply
- Lens: Frosted or clear tempered glass
- cETLus listed
- Fits 1.5" diameter hole
- No UV, no infrared, no radiated heat
- 3 years warranty

## APPLICATIONS

- Steps
- Aisles
- Paths
- Driveways
- Direction lighting
- Information lighting
- Decorative lighting
- Merchandising
- Landscape accents

SPECIFICATIONS		
Product Code	LEDD-Y-XX (ROUND)	LEDD-Y-XX-SQ (SQUARE)
Electrical	Input Voltage	12V AC
	Power Consumption	3W
Specs	Colour Temperature	Cool White 98 lumens @ 5400K; Warm White 95 lumens @ 2900K
	CRI	80+
	Lumen Output	900LM Max.
	Efficacy (LM/W)	83
	Dimmable	Yes
	Beam Angle	120
LED	Type	5050
	Life Span	50,000 Hours
Design	Dimensions (Inches)	2.36 x 3.9"
	Dimensions (Millimeters)	60 x 99mm
	Cover Finish	Stainless steel
	Barrel Finish	Stainless steel
	Max Single Run Length	18 fixtures
	Approved Location	Outdoor
	Mounting	Recessed
Warranty	3 years	
Approvals	cETLus listed and labeled for wet, IC, ceiling, wall and direct burial applications	

NOTE: When installing Mini Disc Lights in harsh environments (such as limestone, salted areas, coastal environments, etc.) please use the stainless steel version to avoid the risk of corrosion to the body of the fixture.

## DIAGRAM

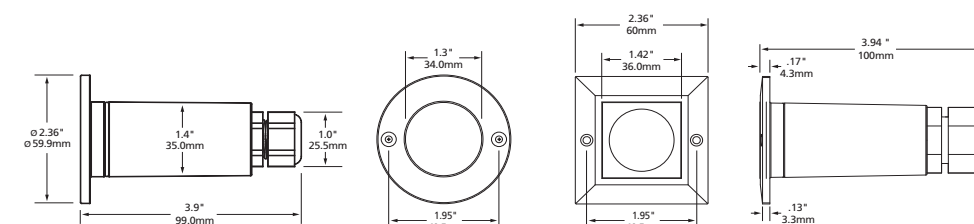

## PRODUCT CODES

### ROUND

#### LEDD-Y-XX

- |                |                |               |
|----------------|----------------|---------------|
| LED Disc Light | TEMPERED GLASS | COLOUR OF LED |
|                | F - Frosted    | WH - 5500K    |
|                | C - Clear      | WW - 2700K    |
|                |                | AM - Amber    |

### SQUARE

#### LEDD-Y-XX-SQ

- |                |                |               |
|----------------|----------------|---------------|
| LED Disc Light | TEMPERED GLASS | COLOUR OF LED |
|                | F - Frosted    | WH - 5500K    |
|                | C - Clear      | WW - 2700K    |
|                |                | AM - Amber    |

## REPLACEMENT LED MODULES

- LEDD-MOD-WH**  
LED Disc Light module, 12V, white LED 5500K
- LEDD-MOD-WW**  
LED Disc Light module, 12V, warm white LED 2700K

## INSTALLATION WIRES

- LW-18G-BUR**  
For outdoor burial connections
- LW-18G-CL2**  
For indoor through wall connections

NOTE: One of the above wires MUST be used in order to maintain product warranty.

## ACCESSORIES



### LEDD-CF

LED Disc Light concrete form for concrete pour applications. Fits over most 3/4" conduit junction boxes.

### LEDD-CF-SQ

LED Disc Light Square concrete form for concrete pour applications. Fits over most 3/4" conduit junction boxes.

## DIMMABLE DRIVERS

### MLDRE-20-12-DM

20 Watts  
Max. recommended load 18 W or 6 LED Disc Lights  
Min. recommended load 8 W or 3 LED Disc Lights  
6.77" x 2.67" x 1.26" (171 x 68 x 32mm)

### MLDRE-60-12-DM

60 Watts  
Max. recommended load 54 W or 18 LED Disc Lights  
Min. recommended load 8 W or 3 LED Disc Lights  
6.77" x 2.67" x 1.26" (171 x 68 x 32mm)

## NON DIMMABLE DRIVERS

### LEDDR-12-20W-HW (Indoor)

20W hardwire  
Input: 100 - 240V AC; Output: 12V DC  
Max. 6 LED Disc Lights  
4 1/8" x 4 1/8" x 1 1/2" (104.8 x 104.8 x 38.1mm)

### LEDDR-12-60W (Indoor/Outdoor)

60W hardwire  
Input: 100 - 240V AC; Output: 12V DC  
Max. 18 LED Disc Lights  
9 11/16" x 2 9/16" x 2 1/16" (246 x 65 x 52mm)

## 100% LED Light Output Chart

With every foot of lead wire and every light fixture, there is voltage loss. With too much voltage loss all light fixtures will not develop 100% of their potential output. Below is a chart of acceptable voltage loss which will maintain 100% of the potential light output of the LED Disc Light. Simply plot the number of LED Disc Light you wish to place on one lead on the horizontal axis, with the total distance from the LED Driver to the last LED Disc Light on the vertical axis. If the resulting plot is at or below the line shown, you will have acceptable voltage loss and your LED Disc Light will output 100% of their potential.

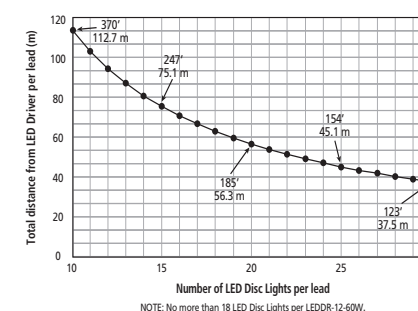

## WARNING: LACK OF DRAINAGE WILL VOID THE WARRANTY

To maintain the warranty, a proper drainage system MUST be installed (drainage material or drainage pipe), when the product is installed in soil or concrete.

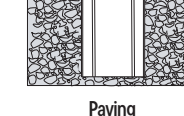
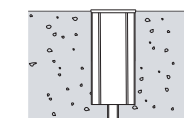

## Test drainage prior to installation.

A quantity of water equal to the volume of the mounting hole should drain in 15 minutes or less.

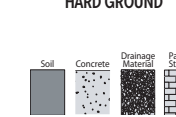
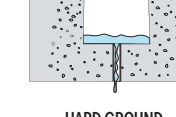
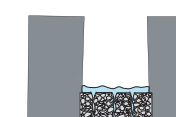

# Mini Disc Marker Light

Robust and energy-efficient, the LED Mini Disc Light, with its durable construction and low 0.24W consumption, suits a multitude of indoor/outdoor applications. It offers long-lasting illumination in both round and square designs, ensuring compatibility with any décor at an affordable cost.



## FEATURES

- Dimmable on the primary power supply side with drivers
- 50,000 hour durability
- Ultra-low consumption: 0.24 watts per fixture
- 12V class 2 safety
- Up to 100 fixtures per supply
- cETLus certified
- Fits 1" diameter, 3.5" depth
- Lens: Frosted Tempered Glass
- 2 years limited warranty, 3 years on stainless steel

## APPLICATIONS

- Steps
- Aisles
- Paths
- Driveways
- Direction lighting
- Information lighting
- Decorative lighting
- Merchandising
- Landscape accents

SPECIFICATIONS			
Product Code	LEDMD-XX-YY (ROUND)		LEDMD-XX-YY-SQ (SQUARE)
Electrical	Input Voltage	12V DC	
	Power Consumption	0.24W	
Specs	Colour Temperature	Cool White 5400K, Warm White 2900K, Blue, Green, Amber, Red	
	CRI	80+	
	Lumen Output	17	
	Efficacy (LM/W)	70	
	Dimmable	Yes	
	Beam Angle	120	
LED	Life Span	50,000 Hours	
Design	Dimensions (Inches)	3 1/4 x 2"	3 1/4 x 1.97"
	Dimensions (Millimeters)	82.6 x 50.8mm	82.6 x 50mm
	Cover Finish	Aluminum, White, Bronze, Black, Stainless Steel	
	Barrel Finish	Aluminum, White, Bronze, Black, Stainless Steel	
	Material	Both cover and barrel are die cast aluminum	
	Lens	Frosted tempered glass	
	Approved Location	Outdoor	
	Mounting	Recessed	
Warranty	3 years		
Approvals	cETLus listed and labeled for wet, IC, ceiling, wall and direct burial applications		

- **NOTE:** When installing Mini Disc Lights in harsh environments (such as limestone, salted areas, coastal environments, etc.) please use the stainless steel version to avoid the risk of corrosion to the body of the fixture.
- Each LED Driver can power up to 200 LED MiniDisc Lights by parallel wiring ("daisy chain") between fixtures.
- **NOTE:** Use LW-18G-CL2 for all in-wall applications, LW-18G-BUR for all burial applications.

## DIAGRAM

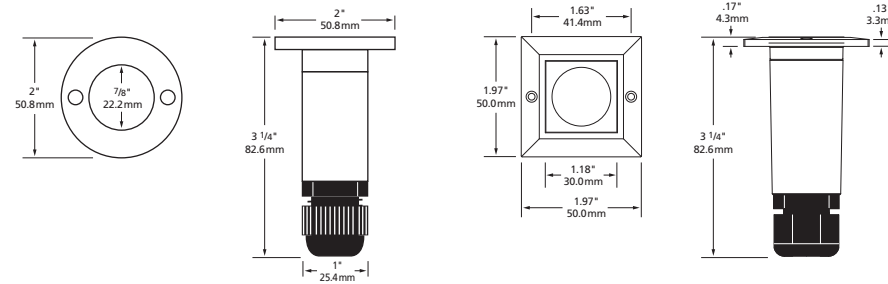

## PRODUCT CODES

ROUND LEDMD-XX-YY		
LED Light	COLOUR OF LED	FINISH
MiniDisc	CW - 5400K	AL - Aluminum
Light	WW - 2900K	WH - White
	AM - Amber	BZ - Bronze
	BL - Blue	BK - Black
	GR - Green	SS - Stainless Steel
	RD - Red	

SQUARE LEDMD-XX-YY-SQ		
LED Light	COLOUR OF LED	FINISH
MiniDisc	CW - 5400K	AL - Aluminum
Light	WW - 2900K	WH - White
	AM - Amber	BZ - Bronze
	BL - Blue	BK - Black
	GR - Green	SS - Stainless Steel
	RD - Red	

## REPLACEMENT LED MODULES

- **LCL-LEDMOD-WH**  
LED Mini Disc Light module, 12V, white LED 5400K
- **LCL-LEDMOD-WW**  
LED Mini Disc Light module, 12V, warm white LED 2900K

## INSTALLATION WIRES

- **LW-18G-BUR**  
For outdoor burial connections
- **LW-18G-CL2**  
For indoor through wall connections

**NOTE:** One of the above wires **MUST** be used in order to maintain product warranty.

## 100% LED Light Output Chart

With every foot of lead wire and every light fixture, there is voltage loss. With too much voltage loss all light fixtures will not develop 100% of their potential output. Below is a chart of acceptable voltage loss which will maintain 100% of the potential light output of the LED Disc Light. Simply plot the number of LED Disc Light you wish to place on one lead on the horizontal axis, with the total distance from the LED Driver to the last LED Disc Light on the vertical axis. If the resulting plot is at or below the line shown, you will have acceptable voltage loss and your LED Disc Light will output 100% of their potential.

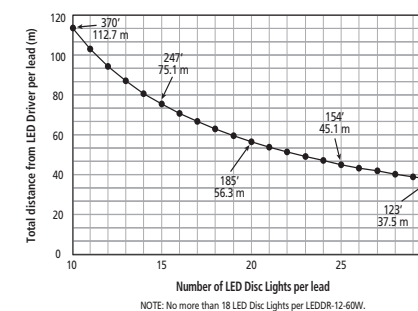

## WARNING: LACK OF DRAINAGE WILL VOID THE WARRANTY

To maintain the warranty, a proper drainage system **MUST** be installed (drainage material or drainage pipe), when the product is installed in soil or concrete.

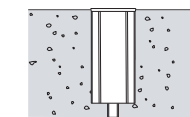

Concrete Installation

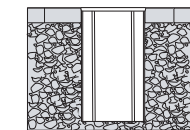

Paving Stones

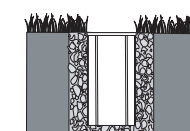

Soil Installation

## Test drainage prior to installation.

A quantity of water equal to the volume of the mounting hole should drain in 15 minutes or less.

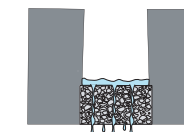

SOFT GROUND

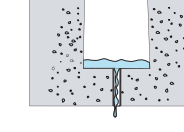

HARD GROUND

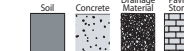

## ACCESSORIES



**LEDMD-CF**  
LED Mini Disc Light concrete form for concrete pour applications. Fits over most 1/2" (12.7mm) conduit junction boxes.

**LEDMD-CF-SQ**  
LED MiniDisc Light Square concrete form for concrete pour applications. Fits over most 1/2" (12.7mm) conduit junction boxes.

## DIMMABLE DRIVERS

**MLDRE-20-12-DM**  
20 Watts  
Max. recommended load 18 W or 75 Mini Disc Lights  
Min. recommended load 8 W or 34 Mini Disc Lights  
6.77" x 2.67" x 1.26" (171 x 68 x 2mm)

**MLDRE-60-12-DM**  
60 Watts  
Max. recommended load 54 W or 200 Mini Disc Lights  
Min. recommended load 8 W or 34 Mini Disc Lights  
6.77" x 2.67" x 1.26" (171 x 68 x 32mm)

## NON DIMMABLE DRIVERS

**LEDDR-12-20W-HW (Indoor)**  
20W hardwire  
Input: 100 - 240V AC  
Output: 12V DC  
Max. 75 Mini Disc Lights  
4 1/8" x 4 1/8" x 1 1/2" (104.8 x 104.8 x 38.1mm)

**LEDDR-12-60W (Indoor/Outdoor)**  
60W hardwire  
Input: 100 - 240V AC  
Output: 12V DC  
Max. 200 Mini Disc Lights  
9 11/16" x 2 9/16" x 2 1/16" (246 x 65 x 52mm)



# Mini Disc Light (Scoop)

The LED Mini Disc Scoop directs light precisely, ideal for stair and theater aisle lighting. It's durable and efficient, offering a 50,000-hour lifespan and low 0.24W consumption, fitting easily into 1" holes. Certified for diverse environments, it ensures safety and versatility with a solid warranty.



## FEATURES

- Dimmable on the primary power supply side with drivers
- 50,000 hour durability
- Ultra-low consumption: 0.24 watts per fixture
- 12V class 2 safety
- Up to 100 fixtures per supply
- cETLus certified
- Fits 1" diameter, 3.5" depth
- Lens: Frosted Tempered Glass
- 2 years limited warranty, 3 years on stainless steel

## APPLICATIONS

- Steps
- Aisles
- Paths
- Driveways
- Direction lighting
- Information lighting
- Decorative lighting
- Merchandising
- Landscape accents

## SPECIFICATIONS

SPECIFICATIONS		LEDMD-S-XX-YY
<b>Product Code</b>	LEDMD-S-XX-YY	
<b>Electrical</b>	Input Voltage	12V DC
	Power Consumption	0.24W
<b>Specs</b>	Colour Temperature	Cool White 5400K, Warm White 2900K, Blue, Green, Amber, Red
	CRI	80+
	Lumen Output	17
	Efficacy (LM/W)	70
	Dimmable	Yes
	Beam Angle	No up-light when mounted with scoop on upper half
<b>LED</b>	Life Span	50,000 Hours
	Dimensions (Inches)	2 x 3 1/4"
<b>Design</b>	Dimensions (Millimeters)	50.8 x 82.6mm
	Cover Finish	Aluminum, White, Bronze, Black
	Barrel Finish	Aluminum, White, Bronze, Black
	Lens	Frosted tempered glass
	Max Single Run Length	200 fixtures
	Approved Location	Outdoor
	Mounting	Recessed
	<b>Warranty</b>	2 years
<b>Approvals</b>	cETLus listed and labeled for wet, IC, ceiling, wall and direct burial applications	

- **NOTE:** When installing Mini Disc Scoop in harsh environments (such as limestone, salted areas, coastal environments, etc.) please use the stainless steel version to avoid the risk of corrosion to the body of the fixture.
- Each LED Driver can power up to 200 Mini Disc Lights by parallel wiring ("daisy chain") between fixtures.
- **NOTE:** Use LW-18G-CL2 for all in-wall applications, LW-18G-BUR for all burial applications.

## DIAGRAM

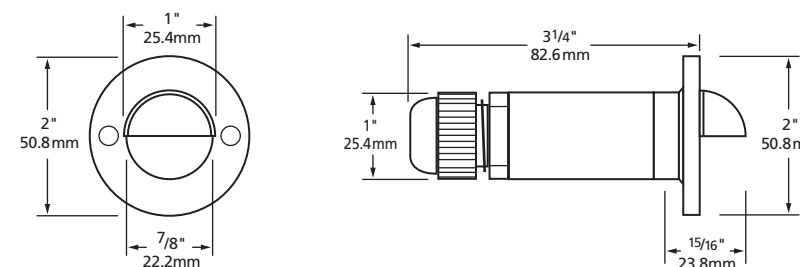

## PRODUCT CODES

### LEDMD-S-XX-YY

LED	COLOUR OF LED	FINISH
Mini Disc Light (Scoop)	CW - 5400K WW - 2900K AM - Amber BL - Blue GR - Green RD - Red	AL - Aluminum WH - White BZ - Bronze BK - Black

## REPLACEMENT LED MODULES

- **LCL-LEDMOD-WH**  
LED Mini Disc Light module, 12V, white LED 5400K
- **LCL-LEDMOD-WW**  
LED Mini Disc Light module, 12V, warm white LED 2900K

## INSTALLATION WIRES

- **LW-18G-BUR**  
For outdoor burial connections
- **LW-18G-CL2**  
For indoor through wall connections

**NOTE:** One of the above wires **MUST** be used in order to maintain product warranty.

## ACCESSORIES



### LEDMD-CF

Concrete form for concrete pour applications. Fits over most 1/2" (12.7mm) conduit junction boxes.

## DIMMABLE DRIVERS

### MLDRE-20-12-DM

20 Watts  
Max. recommended load 18 W or 75 Mini Disc Lights  
Min. recommended load 8 W or 34 Mini Disc Lights

6.77" x 2.67" x 1.26" (171 x 68 x 2mm)

### MLDRE-60-12-DM

60 Watts  
Max. recommended load 54 W or 200 Mini Disc Lights  
Min. recommended load 8 W or 34 Mini Disc Lights

6.77" x 2.67" x 1.26" (171 x 68 x 32mm)

**NOTE:** For outdoor installations, please add E-KO-SR strain relief.

## NON DIMMABLE DRIVERS

### LEDDR-12-20W-HW (Indoor)

20W hardwire  
Input: 100 – 240V AC  
Output: 12V DC  
Max. 75 Mini Disc Lights  
4 1/8" x 4 1/8" x 1 1/2" (104.8 x 104.8 x 38.1mm)

### LEDDR-12-60W (Indoor/Outdoor)

60W hardwire  
Input: 100 – 240V AC  
Output: 12V DC  
Max. 200 Mini Disc Lights  
9 11/16" x 2 9/16" x 2 1/16" (246 x 65 x 52mm)

## 100% LED Light Output Chart

With every foot of lead wire and every light fixture, there is voltage loss. With too much voltage loss all light fixtures will not develop 100% of their potential output. Below is a chart of acceptable voltage loss which will maintain 100% of the potential light output of the LED Disc Light. Simply plot the number of LED Disc Light you wish to place on one lead on the horizontal axis, with the total distance from the LED Driver to the last LED Disc Light on the vertical axis. If the resulting plot is at or below the line shown, you will have acceptable voltage loss and your LED Disc Light will output 100% of their potential.

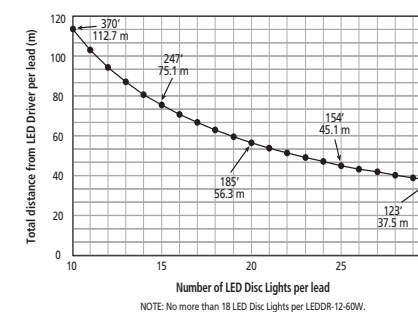

NOTE: No more than 18 LED Disc Lights per LEDDR-12-60W.

## WARNING: LACK OF DRAINAGE WILL VOID THE WARRANTY

To maintain the warranty, a proper drainage system **MUST** be installed (drainage material or drainage pipe), when the product is installed in soil or concrete.

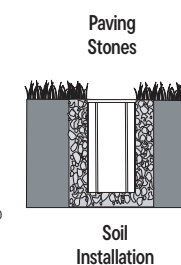
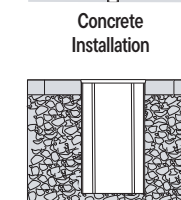
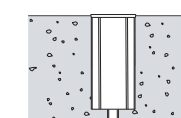

## Test drainage prior to installation.

A quantity of water equal to the volume of the mounting hole should drain in 15 minutes or less.

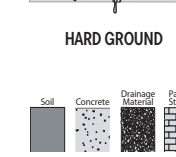
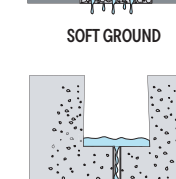
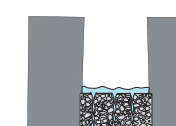

# Disc Light Dome

## Stainless Steel Construction

Durable LED marker light with dimming capability, perfect for indoor and outdoor use. Stainless steel construction ensures longevity in any setting.



### FEATURES

- Dimmable with dimmable power supplies
- Long life – 50,000 hours
- Low power consumption 3 watts per fixture
- Safe 12 volt, Class 2 power supply (not included)
- Up to 30 fixtures per power supply
- cETLus listed
- Fits in any 1.5" diameter hole, 4" long
- Lens: Clear tempered glass
- Available concrete form for concrete pour applications
- 3 years limited warranty

### APPLICATIONS

- Steps
- Aisles
- Paths
- Driveways
- Direction lighting
- Decorative lighting

### SPECIFICATIONS

Product Code		LEDD-C-XX-D
Electrical	Input Voltage	12V DC
	Power Consumption	3W
Specs	Colour Temperature	Cool White 98 lumens @ 5500K; Warm White 95 lumens @ 2700K
	CRI	80+
	Lumen Output	5500K: 98; 2700K: 95
	Efficacy (LM/W)	33
	Dimmable	Yes
LED	Type	5050
	Life Span	50,000 Hours
Design	Dimensions (Inches)	3.9 x 1.95"
	Dimensions (Millimeters)	99 x 49.6mm
	Cover Finish	Stainless Steel (SUS316)
	Barrel Finish	Stainless Steel (SUS316)
	Max Single Run Length	18 fixtures
	Approved Location	Outdoor
Warranty		3 years
Approvals	cETLus listed and labeled for wet, IC, ceiling, wall and direct burial applications	

- **Wiring Options:** Fixtures can be parallel wired or "Daisy chained" together with up to 18 fixtures on our largest dimmable driver.
- **NOTE:** Use LW-18G-CL2 for all in-wall applications. Use LW-18G-BUR for all burial applications.

### DIAGRAM

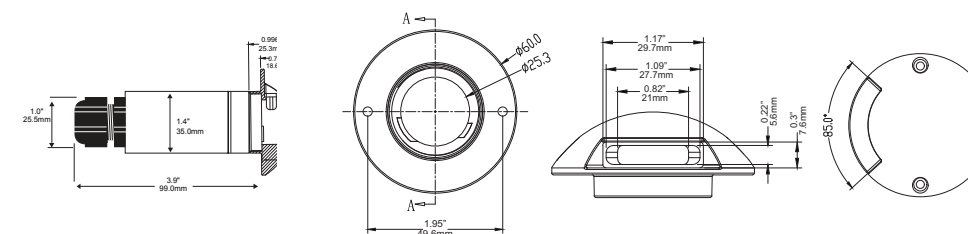

### PRODUCT CODES

LEDD-C-XX-D

LED Disc Light (Dome)  
 COLOUR OF LED  
 WH - 5500K  
 WW - 2700K

### REPLACEMENT LED MODULES

- **LEDD-MOD-WH**  
LED Disc Light module, 12V, white LED 5500K
- **LEDD-MOD-WW**  
LED Disc Light module, 12V, warm white LED 2700K

### INSTALLATION WIRES

- **LW-18G-BUR**  
For outdoor burial connections
- **LW-18G-CL2**  
For indoor through wall connections

NOTE: One of the above wires **MUST** be used in order to maintain product warranty.

### ACCESSORIES



#### LEDD-CF

Recommended for easy installation in concrete pour applications.

### DIMMABLE DRIVERS

#### MLDRE-20-12-DM

20 Watts  
 Max. recommended load 18 W or 6 LED Disc Lights  
 Min. recommended load 8 W or 3 LED Disc Lights  
 6.77" x 2.67" x 1.26" (171 x 68 x 32mm)

#### MLDRE-60-12-DM

60 Watts  
 Max. recommended load 54 W or 18 LED Disc Lights  
 Min. recommended load 8 W or 3 LED Disc Lights  
 6.77" x 2.67" x 1.26" (171 x 68 x 32mm)

NOTE: For outdoor installations, please add E-KO-SR strain relief.

### NON DIMMABLE DRIVERS

#### LEDDR-12-20W-HW (Indoor)

20W hardwire  
 Input: 100 – 240V AC; Output: 12V DC  
 Max. 6 LED Disc Lights  
 4 1/8" x 4 1/8" x 1 1/2" (104.8 x 104.8 x 38.1mm)

#### LEDDR-12-60W (Indoor/Outdoor)

60W hardwire  
 Input: 100 – 240V AC; Output: 12V DC  
 Max. 18 LED Disc Lights  
 9 11/16" x 2 9/16" x 2 1/16" (246 x 65 x 52mm)

### 100% LED Light Output Chart

With every foot of lead wire and every light fixture, there is voltage loss. With too much voltage loss all light fixtures will not develop 100% of their potential output. Below is a chart of acceptable voltage loss which will maintain 100% of the potential light output of the LED Disc Light. Simply plot the number of LED Disc Light you wish to place on one lead on the horizontal axis, with the total distance from the LED Driver to the last LED Disc Light on the vertical axis. If the resulting plot is at or below the line shown, you will have acceptable voltage loss and your LED Disc Light will output 100% of their potential.

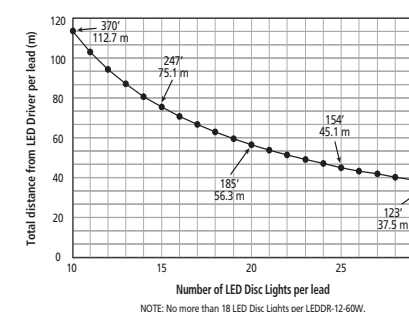

NOTE: No more than 18 LED Disc Lights per LEDDR-12-60W.

### WARNING: LACK OF DRAINAGE WILL VOID THE WARRANTY

To maintain the warranty, a proper drainage system **MUST** be installed (drainage material or drainage pipe), when the product is installed in soil or concrete.

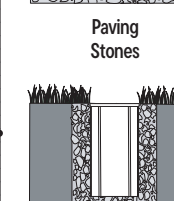
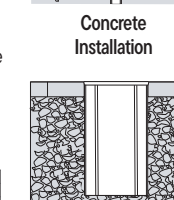
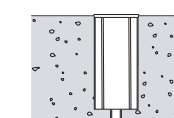

### Test drainage prior to installation.

A quantity of water equal to the volume of the mounting hole should drain in 15 minutes or less.

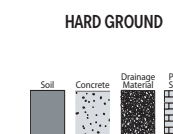
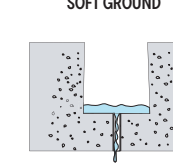
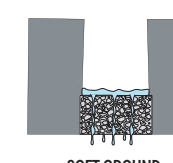

# Well Light

Illuminate columns, fences, and trees discreetly with this well light. Designed for flush installation, it features a robust die-cast aluminum housing and a powerful integrated 6-watt LED. Waterproof and backed by a 15-year warranty.



## FEATURES

- Low-profile design for discreet lighting
- Robust die-cast aluminum construction
- Silicon filled wirenuts
- IP67 rated
- Wet location listed
- Powerful 6-watt integrated LED
- Weatherproof for outdoor durability
- Bright 580-lumen output
- Stylish black finish for modern appeal
- Effortless installation with included sleeve
- Backed by 15 years warranty

## APPLICATIONS

- Column and pillar illumination
- Pathway and boundary lighting
- Tree canopy highlighting
- Garden and seating area visibility
- Water feature enhancement
- Step and stair safety lighting



## SPECIFICATIONS

Product Code	IG-01-12V-36D-BLK		IG-01-12V-60D-BLK
Electrical	Input Voltage	12/24V AC/DC	
	Power Consumption	6W	
Specs	Colour Temperature	3000K	
	CRI	90+	
	Lumen Output	580LM	
	Efficacy (LM/W)	97	
	Dimmable	No	
	IP Rating	IP67	
	Beam Angle	36°	60°
	LED	Type	SMD2835
	Life Span	50,000 Hours	
Design	Dimensions (Inches)	3.03 x 4.02"	
	Dimensions (Millimeters)	76.9 x 102 mm	
	Finish	Black	
	Material	Die-cast Aluminum	
	Cable	Copper	
	Operating Temperature	-20 to 40°C	
	Approved Location	Outdoor	
	Mounting	In-ground	
Warranty	15 years		
Approvals	cETLus		

## DIAGRAM

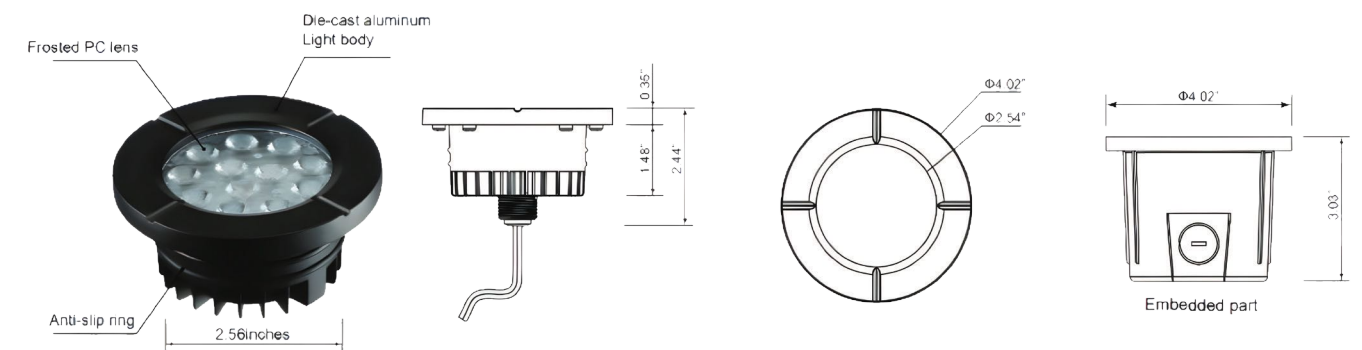

## ACCESSORIES



### ACC-12G-2C-BUR

Landscape burial wire, 12G, 2C - 500ft spool

### ACC-12G-2C-BUR-XX

Landscape burial wire, 12G, 2C - custom cuts

**NOTE:** A transformer is required. See page 108 to 111.



# 12V AC, 100W Transformer

A small transformer for smaller installations. Comes with built in photocell and mechanical timer.



## FEATURES

- Composite body
- Built-in mechanical timer
- Built-in photocell
- 12V/100W output, 120V input
- Transparent sliding lid design
- Overload protection
- IP65 weatherproof
- 72" SJT(W) cable, heavy gauge, grounded and water resistant power cord with molded plug
- 50,000 hour life
- 2 comm terminals
- 12V, 15V terminals
- 15 years warranty
- 7.5" by 4.4" by 4.5"

## SPECIFICATIONS

Product Code		ACC-TR-100W
Electrical	Input Voltage	120V
	Output Voltage	12V AC
	Power	100W
	Max Output Current	8.5A
Specs	Colour Temperature	Cool White 98 lumens @ 5500K; Warm White 95 lumens @ 2700K
	Life Span	50,000 Hours
Design	Dimensions (Inches)	7.5 x 4.33"
	Dimensions (Millimeters)	190 x 110mm
	Finish	Black
	Material	Composite
	Operating Temperature	-20 to 40°C
	Mounting	On Wall
	IP Rating	IP65
Warranty		15 years
Approvals		cETLus



## DIAGRAM

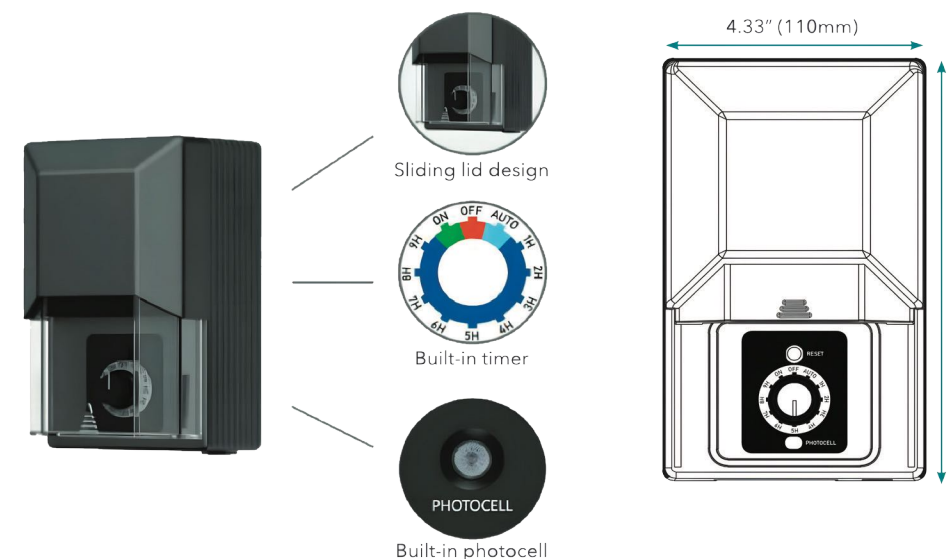

## ACCESSORIES



### ACC-12G-2C-BUR

Landscape burial wire, 12G, 2C - 500ft pool

### ACC-12G-2C-BUR-XX

Landscape burial wire, 12G, 2C - custom cuts

# 12-15V AC, 300W Transformer

A 300W transformer, in a stainless-steel case. Enough power to run most landscape light systems. For bigger properties, run 2 units.



## FEATURES

- Stainless steel case
- 300W output, 110V input
- 1 common terminal, with 12V, 13V, 14V, 15V terminals
- 6.1" by 5.3" by 11.6" dimensions
- Quick mount bracket
- Sealed removable lockable hinged door
- Pre-scored knockout sides and bottom panel
- Tool-less removable bottom panel
- Fully encapsulated Toroid Core
- 304L stainless steel enclosure
- 15 years warranty



SPECIFICATIONS		
Product Code	ACC-TR-300W	
Electrical	Input Voltage	120V
	Output Voltage	12V, 13V, 14V, 15V AC
	Power	300W
	Max Output Current	8.5A
	Primary Protection	25 AMP breaker
Specs	Colour Temperature	Cool White 98 lumens @ 5500K; Warm White 95 lumens @ 2700K
	Life Span	50,000 Hours
Design	Dimensions (Inches)	11.6 x 6.1"
	Dimensions (Millimeters)	295 x 155mm
	Finish	Black
	Material	Composite
	Operating Temperature	-20 to 40°C
	Mounting	On Wall
	IP Rating	IP65
Warranty	15 years	
Approvals	cETLus	

## DIAGRAM



## ACCESSORIES



ACC-DT  
Digital Timer



ACC-PC  
Photocell



ACC-WIFI  
WI-FI Controller



ACC-12G-2C-BUR  
Landscape burial wire, 12G, 2C - 500ft spool

ACC-12G-2C-BUR-XX  
Landscape burial wire, 12G, 2C - custom cuts





# Down Lighting



# 5CCT LED Thin Line Down Light (Round)

Ideal for both commercial and residential settings, this versatile and cost-effective down light offers adjustable 5 color temperatures.



## FEATURES

- TRIAC dimmable
- 120° beam spread
- Adjustable colour temperature
- Two spring loaded clips to attach to any ceiling material
- White finish (interchangeable: brushed nickel, black, bronze trim rings available - sold separately)
- Wet locations listed
- Temperature rating: -20°C to 45°C
- No IC can required, for direct contact with insulation and combustible materials
- Connects directly to 120V power supply
- Optional 347V Step-Down
- Transformer (non-dimmable)

## APPLICATIONS

- Kitchens & pantries
- Laundry rooms
- Bathrooms
- Lobbies & hallways
- Banquet halls & elevators
- Retail lighting
- Offices & restaurants

## SPECIFICATIONS

Size	3 Inches	4 Inches	6 Inches	8 Inches	10 Inches
<b>Product Code</b>	DL-5CCT-3-WH	DL-5CCT-4-WH	DL-5CCT-6-WH	DL-5CCT-8-WH	DL-5CCT-10-WH
<b>Electrical</b>	Input Voltage: 120V AC Power Consumption: 6W, 9W, 12W, 15W, 20W Color Temperature: 2700/3000/3500/4000/5000K Lumen Output: 420-445, 627-684, 995-1117, 1368-1465, 1817-1944 Efficacy: 70LM/W CRI: 90 Dimmable: Yes (TRIAC) Beam Angle: 120°				
<b>Specs</b>	Type: Epistar Life Span: 50,000 Hours				
<b>LED</b>	Dimensions (Inches): 3.1 x 3.8 x .5", 4 x 4.7 x .5", 6.14 x 6.85 x 0.5", 8 x 8.9 x 0.5", 10 x 10.8 x 0.5" Dimensions (Millimeters): 80 x 95.5 x 11.5mm, 101 x 120.1 x 11.5mm, 150 x 174.5 x 11.5mm, 220 x 226 x 11.5mm, 254 x 274 x 11.5mm Installation Hole Size: 3.35" (85mm), 4.33" (110mm), 6.3" (160mm), 8.27" (210mm), 10.16" (258mm)				
<b>Design</b>	Finish: White Trim Finish: BK: Black, BZ: Bronze, BN: Brushed Nickel Operating Temperature: -20°C to 45°C Approved Location: Wet Mounting: Ceiling via spring loaded clips				
<b>Warranty</b>	5 years				
<b>Approvals</b>	cETLus and Energy Star				

## PRODUCT CODES

DL-5CCT-YY-WH  
 5CCT LED Thin-Line Down Lights  
 SIZE: 3: 3", 4: 4", 6: 6", 8: 8", 10: 10"

## ROUND TRIM RINGS (Sold Separately)

- LVLDL - 03 - TR - XX - L3
- LVLDL - 04 - TR - XX - L3
- LVLDL - 06 - TR - XX - L3
- LVLDL - 08 - TR - XX - L3
- LVLDL - 10 - TR - XX - L3

TRIM RING FINISH  
 BK: Black, BZ: Bronze; BN - Brushed Nickel

## DIAGRAM

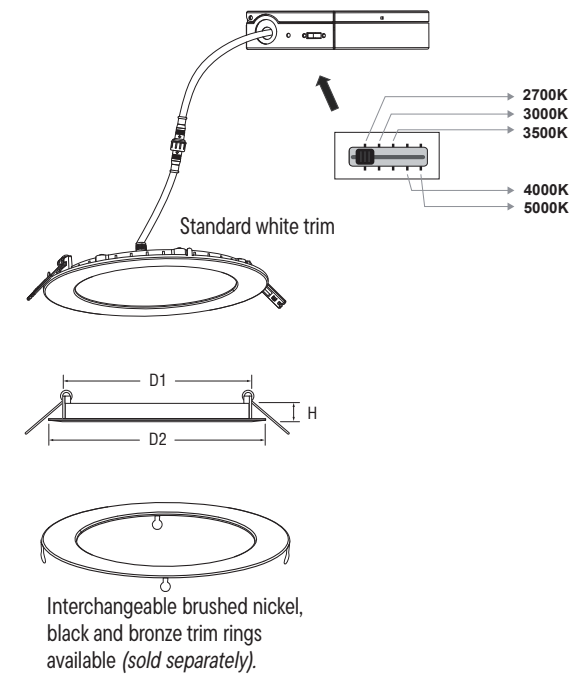

## ACCESSORIES



LVLDL-YY-TR-XX-L3  
 Trim Rings For 5 CCT LED Thin Line Down Light (sold separately).

## CONSTRUCTION PLATES

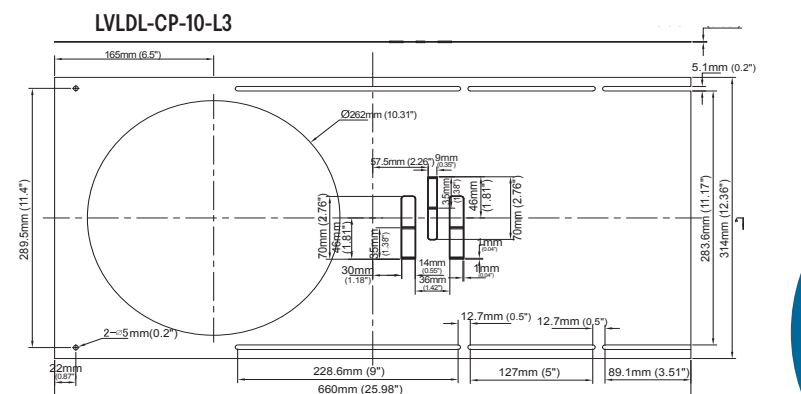
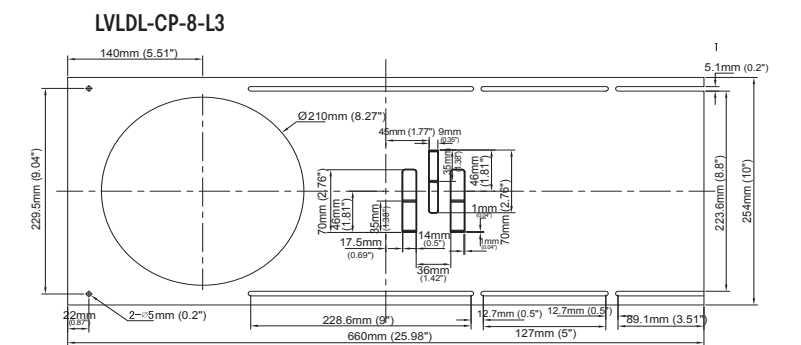
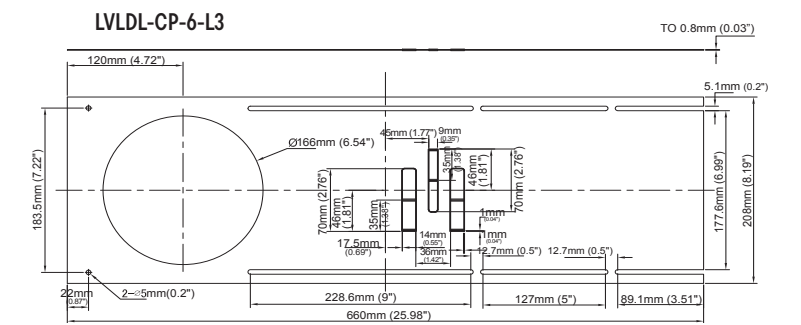
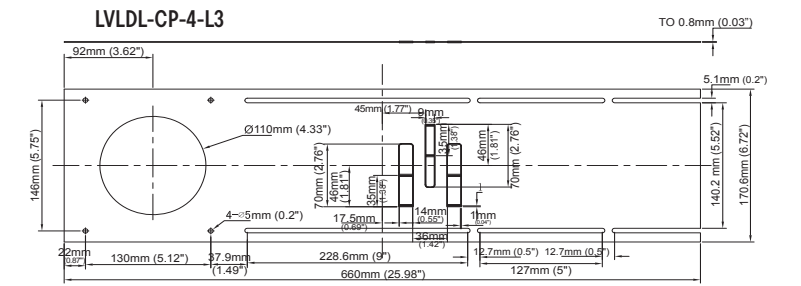
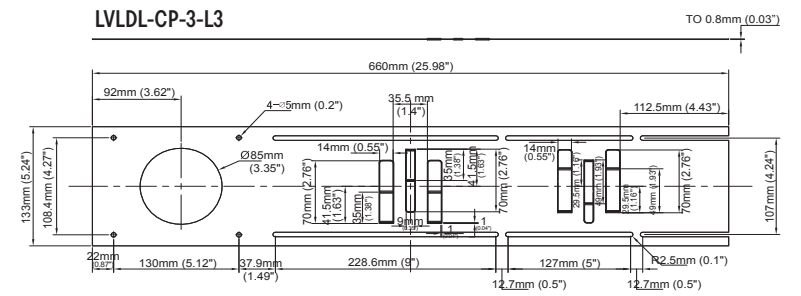

# 5CCT LED Thin Line Down Light (Square)

Designed with a sleek square shape, this down light offers versatility, affordability, and adjustable 5 color temperatures.



## FEATURES

- TRIAC dimmable
- 120° beam spread
- Adjustable colour temperature
- Two spring loaded clips to attach to any ceiling material
- White finish (interchangeable: brushed nickel, black, bronze trim rings available - sold separately)
- Wet locations listed
- Temperature rating: -20°C to 45°C
- No IC can required, for direct contact with insulation and combustible materials
- Connects directly to 120V power supply
- Optional 347V Step-Down
- Transformer (non-dimmable)

## APPLICATIONS

- Kitchens & pantries
- Laundry rooms
- Bathrooms
- Lobbies & hallways
- Banquet halls & elevators
- Retail lighting
- Offices & restaurants

## SPECIFICATIONS

Size	4 Inches	6 Inches
Product Code	DL-5CCT-4S-WH	DL-5CCT-6S-WH
Electrical	Input Voltage	120V AC
	Power Consumption	9W / 12W
Specs	Color Temperature	2700/3000/3500/4000/5000K
	Lumen Output	630 / 840
	Efficacy	70LM/W
	CRI	90
	Dimmable	Yes (TRIAC)
	Beam Angle	120°
LED	Type	Epistar
	Life Span	50,000 Hours
Design	Dimensions (Inches)	4.1 x 4.7 x .4" / 6.3 x 6.8 x .4"
	Dimensions (Millimeters)	103 x 120 x 11.3mm / 159 x 171.5 x 11.3mm
	Installation Hole Size	4.33" (110mm) / 6.30" (160mm)
	Finish	White
	Trim Finish	BK: Black, BZ: Bronze, BN: Brushed Nickel
	Operating Temperature	-20°C to 45°C
	Approved Location	Wet
	Mounting	Ceiling via spring loaded clips
Warranty	5 years	
Approvals	cETLus and Energy Star	

## PRODUCT CODES

DL-5CCT-YY-WH

5CCT LED Thin-Line Down Lights  
 SIZE (Square)  
 4S: 4"  
 6S: 6"

SQUARE TRIM RINGS (Sold Separately)

LVLDL - 04S - TR - XX - L3  
 LVLDL - 06S - TR - XX - L3

TRIM RING FINISH  
 BK: Black, BZ: Bronze, BN - Brushed Nickel

## DIAGRAM

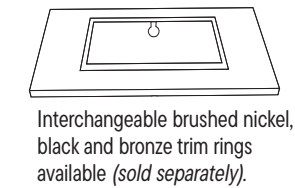
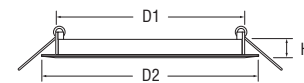
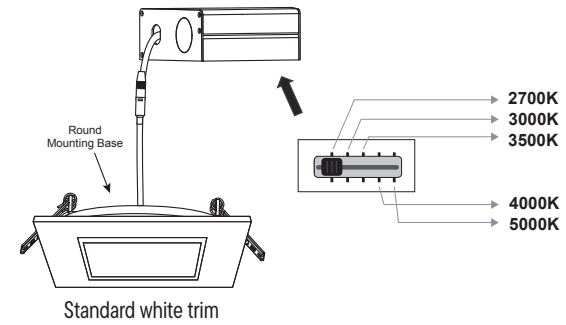

## ACCESSORIES

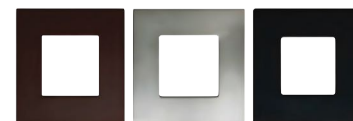

LVLDL-YY-TR-XX-L3  
 Square Shaped Trim Rings For 5 CCT LED Thin Line Down Light (sold separately).

## CONSTRUCTION PLATES

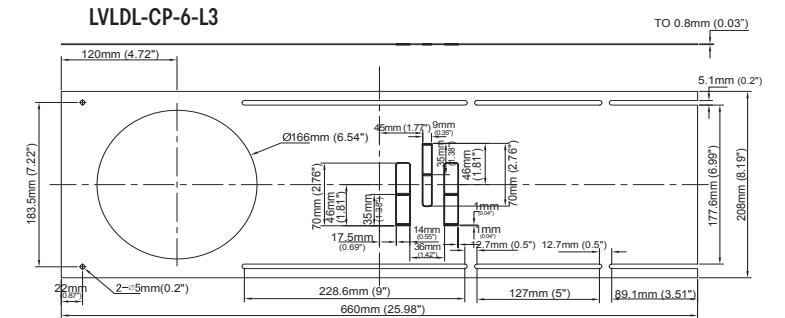
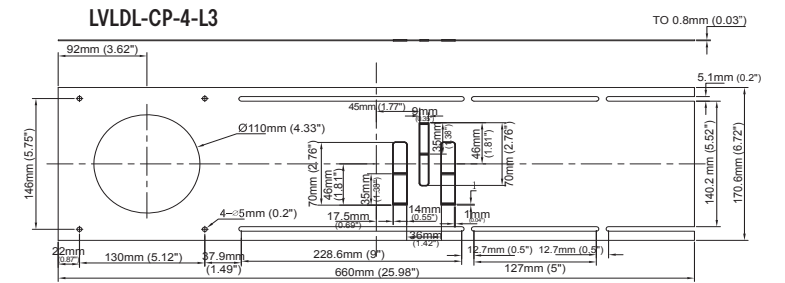

# Regressed Down Light (CCT)

Ideal for both new builds and remodeling projects, these versatile and cost-effective downlights come in two configurations: one allows to easily adjust the color temperature with a slider switch (2700/3000/4000K), while the other offers the flexibility of Bluetooth to select any color temperature from 2700K to 5000K.



## FEATURES

- Two convenient options: Slider Switch CCT adjustable and Bluetooth CCT adjustable
- Dimmable: Slider Switch CCT Adjustable with Electronic Low Voltage (ELV) dimmers, and Bluetooth CCT Adjustable through the smartphone app
- Two spring loaded clips to attach to any ceiling material
- White finish; Interchangeable satin nickel, black and bronze trim rings available (sold separately)
- Bluetooth CCT Adjustable linkable up to 100 fixtures, individual and zonal control possible through the smartphone app
- Regressed design to reduce glare
- Suitable for damp locations
- Temperature rating: -20°C to 45°C
- The driver is wired for 120V input
- Optional 347V Step-Down Transformer
- 50,000 hour life
- 3 years limited warranty

## APPLICATIONS

- Lobbies
- Office lighting
- Hallways
- Under cabinet
- Banquet halls
- In cabinet
- Elevators
- Wall mount for regress lighting
- Stairways
- Retail
- Under soffits (outdoor)
- Restaurants

## SPECIFICATIONS

Type	CCT Switch Adjustable		CCT Bluetooth Adjustable	
Product Code	RGL-4B-9W-SW (4")	RGL-6B-12W-SW (6")	RGL-4B-9W-BT (4")	RGL-6B-9W-BT (6")
Electrical	Input Voltage: 100-277V AC			
	Power Consumption: 9W	12W	9W	12W
Specs	Color Temperature: 2700/3000/4000K (Slider Switch CCT Adjustable)		2700-5000K (Bluetooth CCT Adjustable)	
	Lumen Output: 630LM	840LM	630LM	840LM
	Efficacy: 70LM/W			
	CRI: 90+			
	Dimmable: Yes			
	Beam Angle: 120°			
LED	Life Span: 50,000 Hours			
Design	Dimensions (Inches): .86 x .511"	.86 x .716"	.86 x .511"	.86 x .716"
	Dimensions (Millimeters): 22 x 130mm	22 x 182mm	22 x 130mm	22 x 182mm
	Installation Hole Size: 4.13" (105mm)	6.18" (157mm)	4.13" (105mm)	6.18" (157mm)
	Finish: White			
	Trim Finish: BK: Black, BZ: Bronze, SN: Satin Nickel			
	Operating Temperature: -20°C to 40°C			
	Approved Location: Indoor			
Mounting: Ceiling via spring loaded clips				
Warranty: 3 years				
Approvals: cETLus listed for damp locations and Energy Star				

## PRODUCT CODES

CCT SWITCH ADJUSTABLE  
RGL - 4B - 9W - SW  
RGL - 6B - 12W - SW

CCT BLUETOOTH ADJUSTABLE  
RGL - 4B - 9W - BT  
RGL - 6B - 12W - BT

TRIM RINGS  
(Sold Separately)  
RGL - 4 - TR - XX  
RGL - 6 - TR - XX

TRIM RING FINISH  
BK - Black  
BZ - Bronze  
SN - Satin Nickel

## STEP-DOWN TRANSFORMERS

DLT-347  
Step-down transformer 347/120V AC 25VA (non-dimmable)

DLT-60-347  
Step-down transformer 347/120V AC 60VA (non-dimmable)

DLT-100-347  
Step-down transformer 347/120V AC 100VA (non-dimmable)

## DIAGRAM

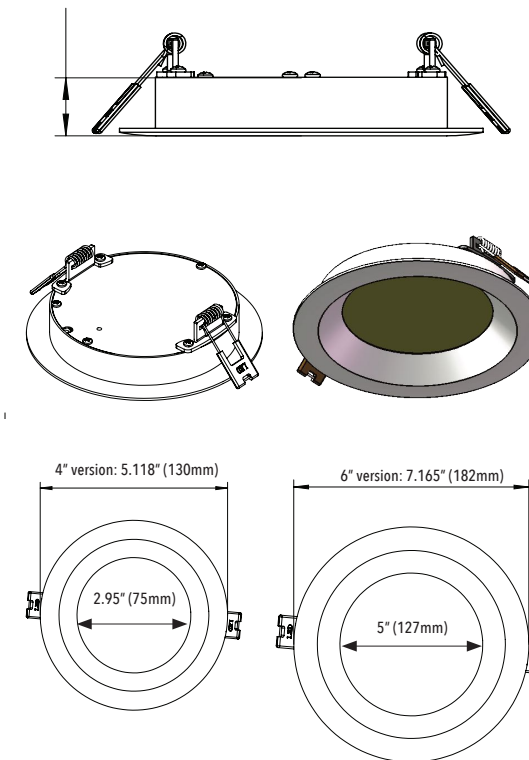

## CONSTRUCTION PLATES

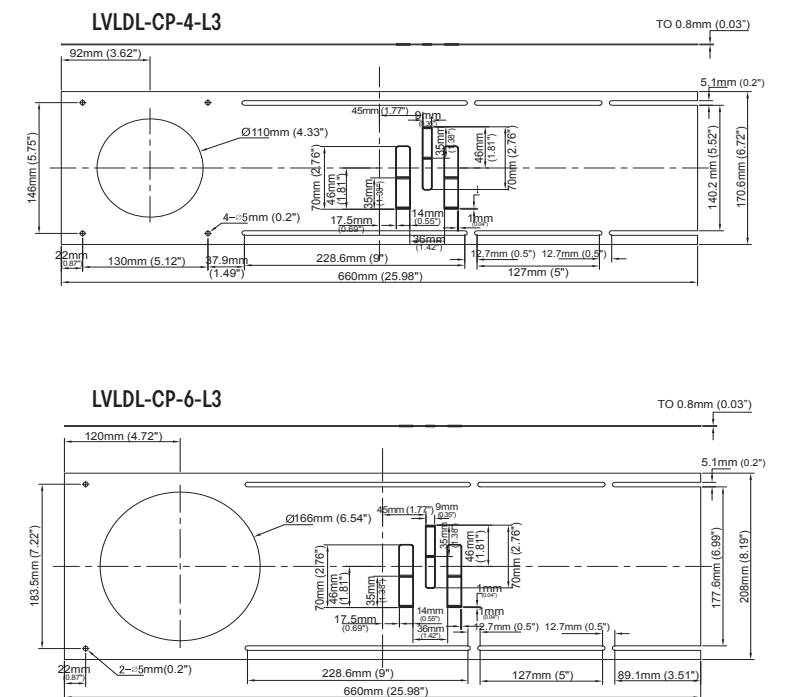

## ACCESSORIES



RGL-4-TR-XX  
RGL-6-TR-XX [XX= BK=(Black), BZ=(Bronze), SN=(Satin Nickel)]  
Trim Rings For 5 CCT LED Thin Line Down Light (sold separately).



# 5CCT LED Gimbal Down Light

Ideal for directional lighting in both remodels and new constructions, 5CCT LED Gimbal Down Lights provide a flexible and cost-effective option across a broad range of uses.

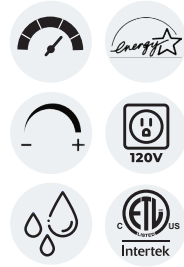

## FEATURES

- 120V AC input voltage
- TRIAC dimmable
- Low power consumption: 8/ 14/18W
- Available in 3", 4" and 6"
- Luminous flux: 600-650LM/ 950-1000LM/ 1150-1200LM
- CCT adjustable: 2700/ 3000/ 3500/4000/ 5000K
- 30,000 hour life
- 360° rotation
- Beam angle: 38°
- Tilting angle: 90°
- 90CRI
- cETLus, Energy Star certified
- 5 years limited warranty
- Airtight

## APPLICATIONS

- |                    |                   |
|--------------------|-------------------|
| <b>RESIDENTIAL</b> | <b>COMMERCIAL</b> |
| • Kitchens         | • Lobbies         |
| • Pantries         | • Hallways        |
| • Laundry rooms    | • Elevators       |
| • Bathrooms        | • Stairways       |
|                    | • Retail          |
|                    | • Restaurants     |
|                    | • Office lighting |

## SPECIFICATIONS

Size	3 Inches	4 Inches	6 Inches	
<b>Product Code</b>	GDL-3-8W-38-CCT-WH	GDL-4-14W-38-CCT-WH	GDL-6-18W-38-CCT-WH	
<b>Electrical</b>	Input Voltage	120V AC		
	Power Consumption	8W	14W	18W
<b>Specs</b>	Color Temperature	2700/3000/3500/4000/5000K		
	Luminous Flux	600-650LM	950-1000LM	1150-1200LM
	CRI	90+		
	Dimmable	Yes, TRIAC dimmable		
	Beam Angle	38°		
	Rotation	360°		
<b>LED</b>	Type	High Brightness COB LED		
	Life Span	30,000 Hours		
<b>Design</b>	Dimensions (Inches)	1.3 x 3.35"	1.42 x 4.41"	2.09 x 6.02"
	Dimensions (Millimeters)	33 x 85mm	36 x 112mm	53 x 153mm
	Installation Hole Size	3 3/8" (85mm)	4 7/16" (112mm)	6" (153mm)
	Finish	White		
	Operating Temperature	-20°C to 40°C		
<b>Warranty</b>	Approved Location	Indoor/Outdoor		
	Mounting	Ceiling via spring loaded clips		
<b>Warranty</b>	5 years			
<b>Approvals</b>	cETLus and Energy Star			

## PRODUCT CODES

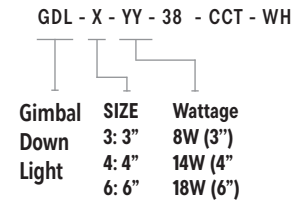

## DIAGRAM

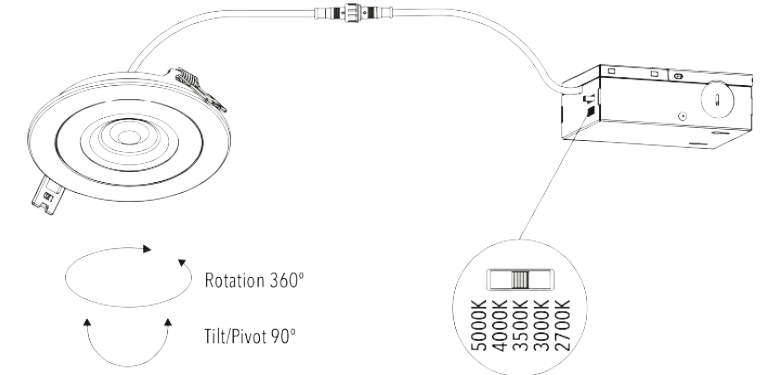

## DIMENSIONS

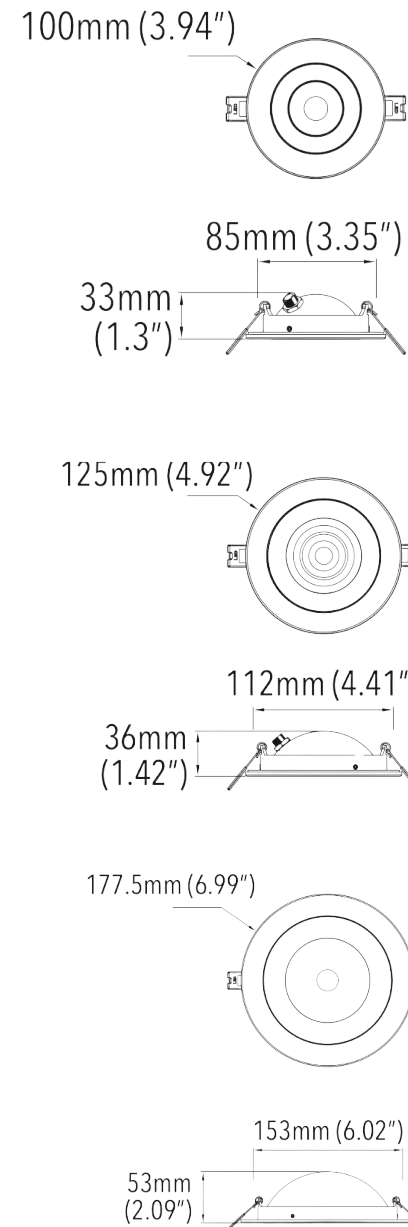

## CONSTRUCTION PLATES

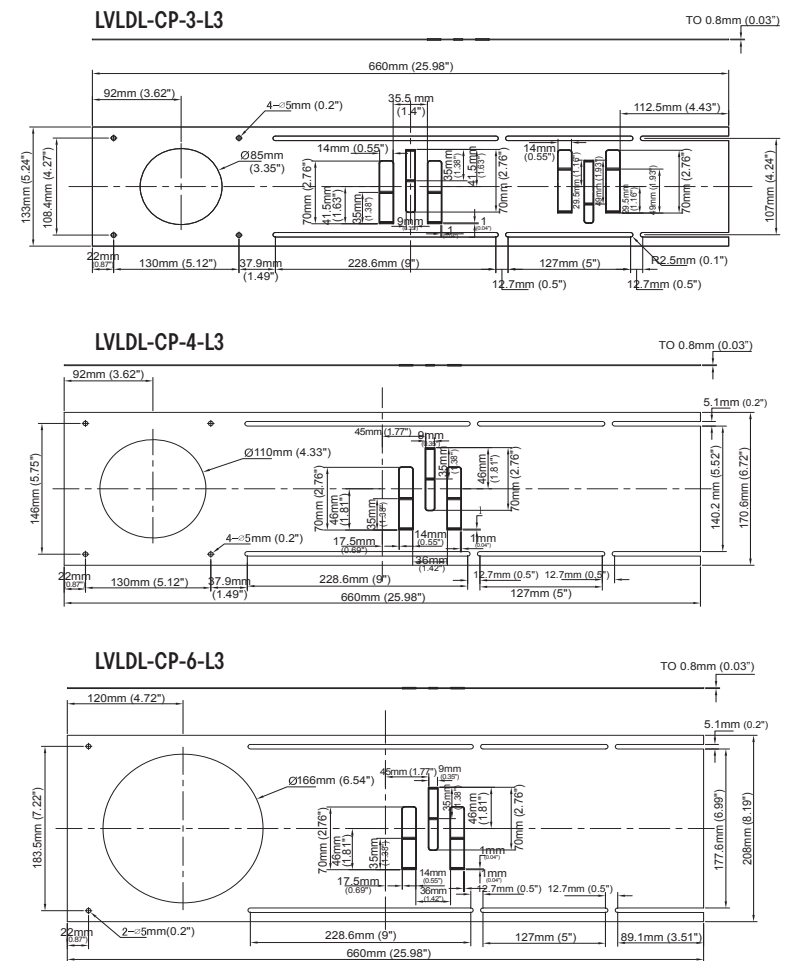

# Surface Mount Down Lights (ROUND)



The LED Surface Mount Down Light offers a streamlined solution for efficient lighting. Built-in Driver on Board (DOB) technology allows for easy ceiling installation without an external driver. Perfect for enhancing any residential or commercial space.

## FEATURES

- DOB technology provides a 120V alternating current source and eliminates the need for traditional LED driver
- Quick & easy to install on standard junction box, ceiling mount with mounting plate
- Temperature rating: -20° to 40°C
- Die-cast aluminum housing
- Smooth and continuous dimming with most ELV dimmers
- Rated for 50,000 hours
- No light bulbs to replace or dispose
- Instant full brightness (including in sub-zero temperatures)
- 80+ CRI
- cETLus listed for wet locations
- 5 years limited warranty

## APPLICATIONS

- |   |  |
|---|--|
| <b>RESIDENTIAL</b>  | <b>COMMERCIAL</b>  |
| <ul style="list-style-type: none"> <li>• Kitchens</li> <li>• Pantries</li> <li>• Laundry rooms</li> <li>• Under cabinet</li> <li>• In cabinet</li> <li>• Under soffits (Outdoor)</li> </ul> | <ul style="list-style-type: none"> <li>• Lobbies &amp; hallways</li> <li>• Banquet halls</li> <li>• Elevators &amp; stairways</li> <li>• Retail &amp; restaurants</li> <li>• Under cabinet</li> <li>• In cabinet</li> <li>• Wall mount for regress lighting</li> </ul> |

## SPECIFICATIONS

Size	6 Inches	8 Inches	10 Inches	12 Inches
<b>Product Code</b>	LVLDL-SR-06-XX-WH-L	LVLDL-SR-08-XX-WH-L	LVLDL-SR-10-XX-WH-L	LVLDL-SR-12-XX-WH-L
<b>Electrical</b>	120V AC			
Input Voltage	120V AC			
Power Consumption	11W	14W	17W	22W
<b>Specs</b>	3000/4000K			
Color Temperature	3000/4000K			
Lumen Output	880WW, 900NW	1000WW, 1050NW	1200WW, 1250NW	1800WW, 1850NW
Efficacy	80WW, 82NW	71WW, 75NW	70WW, 73NW	82WW, 84NW
CRI	80+			
Dimmable	Yes (with most ELV dimmers)			
Beam Angle	120°			
<b>LED</b>	Epistar			
Type	Epistar			
Life Span	50,000 Hours			
<b>Design</b>	Die-cast aluminum housing			
Dimensions (Inches)	6" D x 1" H	8" D x 1" H	10" D x 1" H	12" D x 1" H
Dimensions (Millimeters)	152mm D x 25mm H	203mm D x 25mm H	254mm D x 25mm H	305mm D x 25mm H
Product Material	Die-cast aluminum housing			
Trim Finish	BK: Black, BZ: Bronze, BN: Brushed Nickel			
Operating Temperature	-20°C to 40°C			
Approved Location	Kitchens, pantries, laundry areas, and under soffits (outdoors)			
Mounting	Surface via screw-fixed mounting plate			
<b>Warranty</b>	5 years			
<b>Approvals</b>	cETLus listed for wet locations and Energy Star			

## PRODUCT CODES

LVLDL - SR - YY - XX - WH - L

Round LED Surface Mount Down Light

SIZE  
06 - 6"  
08 - 8"  
10 - 10"  
12 - 12"

LED Colour  
WW: 3000K  
NW: 4000K

ROUND TRIM RINGS (Sold Separately)  
LVLDL - SR - 06 - TR - XX - L  
LVLDL - SR - 08 - TR - XX - L  
LVLDL - SR - 10 - TR - XX - L  
LVLDL - SR - 12 - TR - XX - L

TRIM RING FINISH  
BK: Black, BZ: Bronze, SN: Satin Nickel

## DIAGRAM

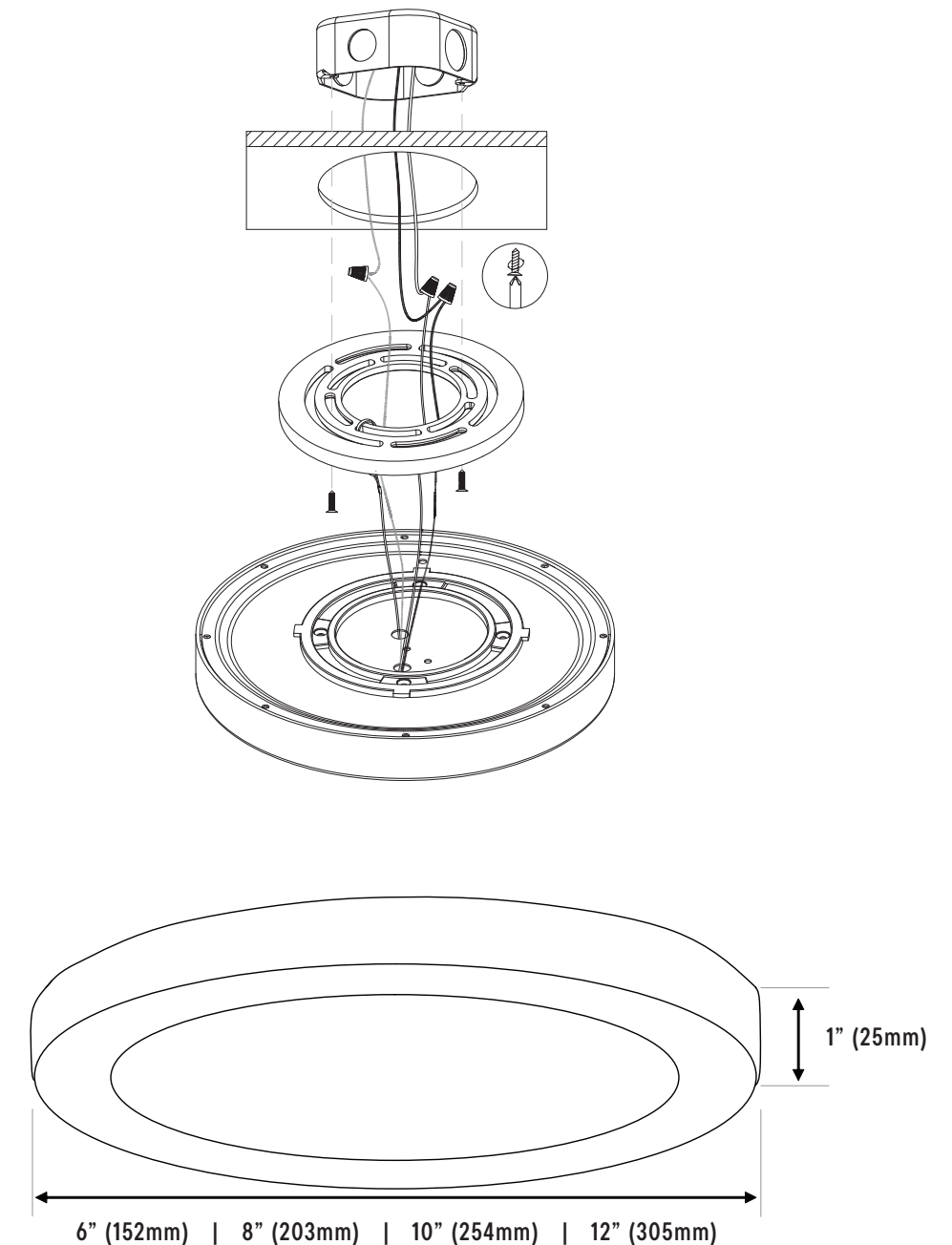

# Surface Mount Down Lights (SQUARE)



The Square LED Surface Mount Down Light, with its compact, square design and DOB technology, requires no external driver for ceiling mounting. Directly fits into 4" junction boxes, suitable for widespread lighting in residential or commercial spaces.

## FEATURES

- DOB technology provides a 120V alternating current source and eliminates the need for traditional LED driver
- Quick & easy to install on standard junction box, ceiling mount with mounting plate
- Temperature rating: -20° to 40°C
- Die-cast aluminum housing
- Smooth and continuous dimming with most ELV dimmers
- Rated for 50,000 hours
- No light bulbs to replace or dispose
- Instant full brightness (including in sub-zero temperatures)
- 80+ CRI
- cETLus listed for wet locations
- 5 years limited warranty

## APPLICATIONS

- |   |  |
|---|--|
| <b>RESIDENTIAL</b>  | <b>COMMERCIAL</b>  |
| <ul style="list-style-type: none"> <li>• Kitchens</li> <li>• Pantries</li> <li>• Laundry rooms</li> <li>• Under cabinet</li> <li>• In cabinet</li> <li>• Under soffits (Outdoor)</li> </ul> | <ul style="list-style-type: none"> <li>• Lobbies &amp; hallways</li> <li>• Banquet halls</li> <li>• Elevators &amp; stairways</li> <li>• Retail &amp; restaurants</li> <li>• Under cabinet</li> <li>• In cabinet</li> <li>• Wall mount for regress lighting</li> </ul> |

## SPECIFICATIONS

Size	6 Inches	8 Inches	10 Inches	12 Inches	
<b>Product Code</b>	LVLDL-SS-06-XX-WH-L	LVLDL-SS-08-XX-WH-L	LVLDL-SS-10-XX-WH-L	LVLDL-SS-12-XX-WH-L	
<b>Electrical</b>	<b>Input Voltage</b> 120V AC				
	<b>Power Consumption</b> 11W	14W	17W	22W	
<b>Specs</b>	<b>Color Temperature</b> 3000/4000K				
	<b>Lumen Output</b>	880WW, 900NW	1000WW, 1050NW	1200WW, 1250NW	1800WW, 1850NW
	<b>Efficacy</b>	80WW, 82NW	71WW, 75NW	70WW, 73NW	82WW, 84NW
	<b>CRI</b>	80+			
	<b>Dimmable</b>	Yes (with most ELV dimmers)			
	<b>Beam Angle</b>	120°			
<b>LED</b>	<b>Type</b> Epistar				
	<b>Life Span</b> 50,000 Hours				
<b>Design</b>	<b>Dimensions (Inches)</b>	6" D x 1" H	8" D x 1" H	10" D x 1" H	12" D x 1" H
	<b>Dimensions (Millimeters)</b>	152mm D x 25mm H	203mm D x 25mm H	254mm D x 25mm H	305mm D x 25mm H
	<b>Product Material</b>	Die-cast aluminum housing			
	<b>Trim Finish</b>	BK: Black, BZ: Bronze, BN: Brushed Nickel			
	<b>Operating Temperature</b>	-20°C to 40°C			
	<b>Approved Location</b>	Kitchens, pantries, laundry areas, and under soffits (outdoors)			
	<b>Mounting</b>	Surface via screw-fixed mounting plate			
	<b>Warranty</b>	5 years			
<b>Approvals</b>	cETLus listed for wet locations and Energy Star				

## PRODUCT CODES

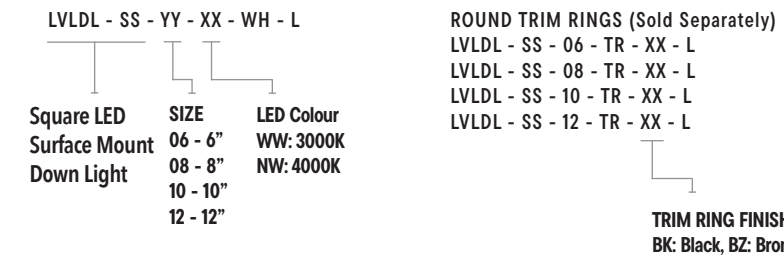

## DIAGRAM

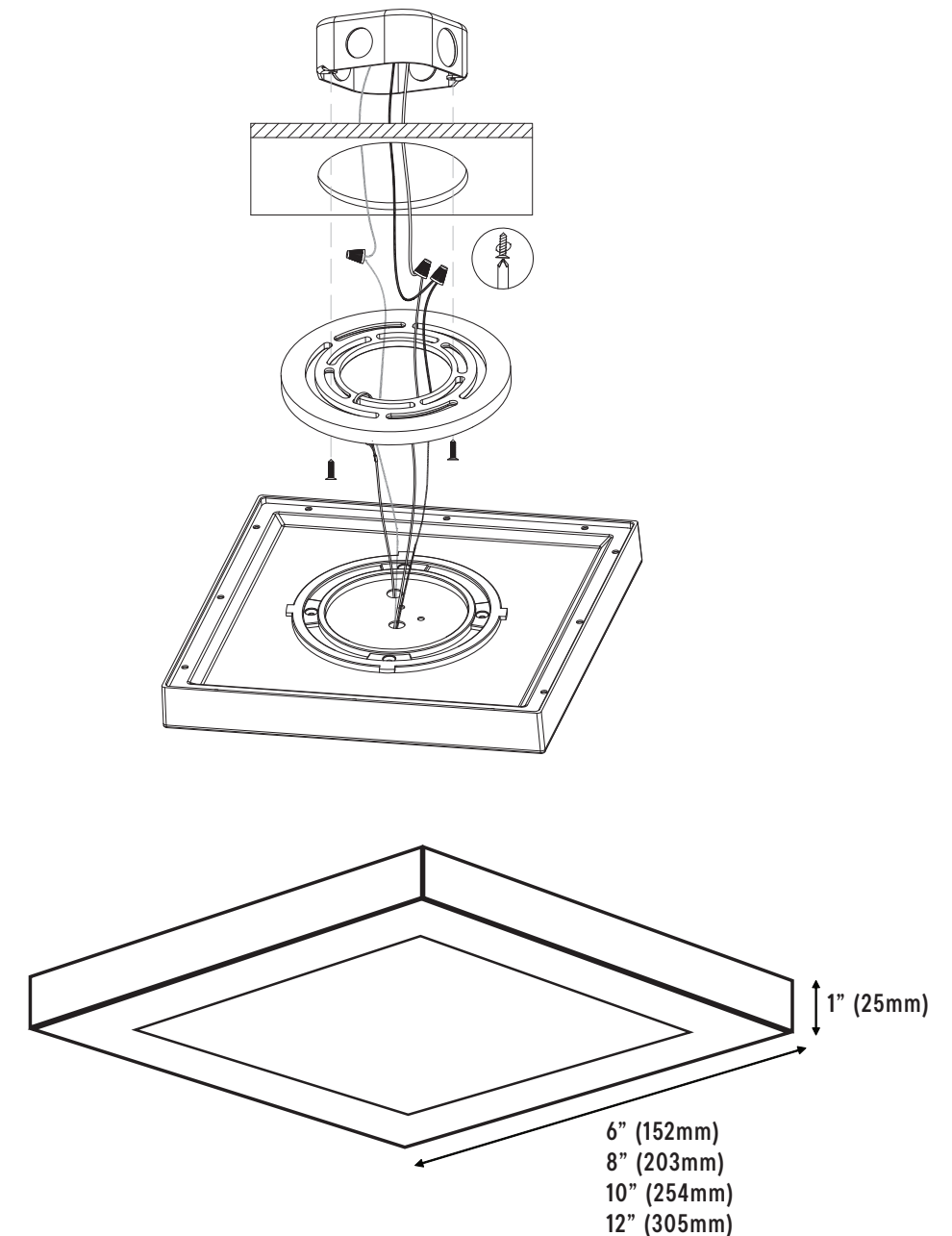



# Ceiling Lights

Ceiling lights are versatile, designed to fit any interior, whether at home or in a business. They serve as direct replacements for traditional ceiling fixtures, offering both aesthetic appeal and energy efficiency.



## FEATURES

- Elegant and energy efficient design
- Available in brushed nickel trim
- Suitable for damp location
- Input voltage: 120VAC
- Dimmable with most ELV dimmers
- 50,000 hours life
- cETLus listed
- Easy installation
- Maintenance free
- Even light distribution
- 5 year warranty

## APPLICATIONS

- |                    |                        |
|--------------------|------------------------|
| <b>RESIDENTIAL</b> | <b>COMMERCIAL</b>      |
| • Kitchens         | • Lobbies              |
| • Pantries         | • Hallways             |
| • Laundry rooms    | • Elevators            |
| • Bathrooms        | • Stairways            |
|                    | • Retail & restaurants |

SPECIFICATIONS		
<b>Product Code</b>	CLD-1625-XXK-BN	
<b>Electrical</b>	<b>Input Voltage</b>	120V AC
	<b>Power Consumption</b>	25W
<b>Specs</b>	<b>Colour Temperature</b>	3000K
	<b>CRI</b>	80
	<b>Lumen Output</b>	1875LM
	<b>Dimmable</b>	Yes (with most ELV dimmers)
	<b>Beam Angle</b>	120°
<b>LED</b>	<b>Life Span</b>	50,000 Hours
<b>Design</b>	<b>Dimensions (Inches)</b>	18.87 x 3.65"
	<b>Dimensions (Millimeters)</b>	403 x 93mm
	<b>Finish Colour / Trims</b>	Brushed Nickel
	<b>Product Material</b>	Metal/Acrylic
	<b>Approved Location</b>	Indoor
	<b>Mounting</b>	Ceiling
<b>Warranty</b>	5 years	
<b>Approvals</b>	cETLus and Energy Star	

NOTE: MOQ may apply.

## PRODUCT CODES

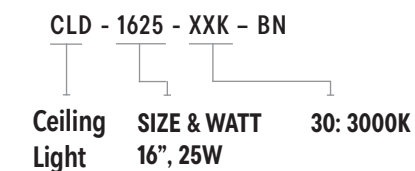

## DIAGRAM

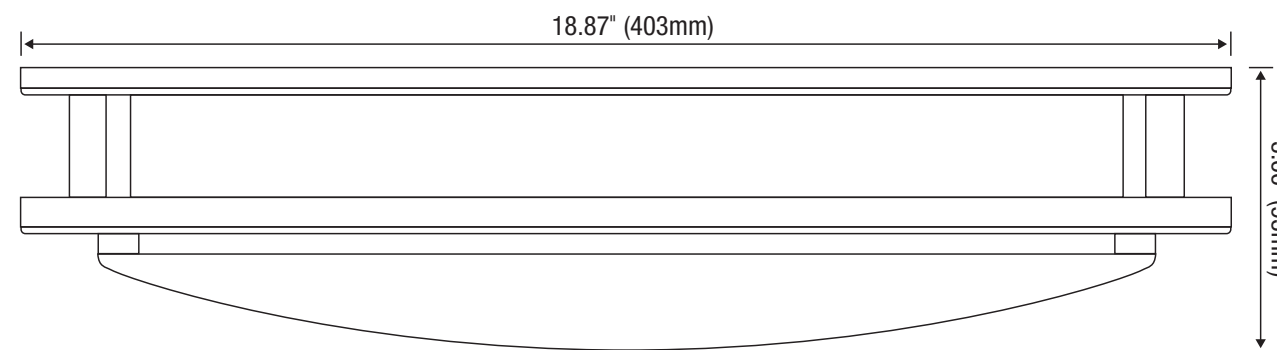

# Wall Sconce

Beautifully designed, elegant and a great addition to any decor, Wall Sconces will compliment any designer look. These fixtures can replace any existing indoor accent lighting, creating tremendous energy savings, at an extremely affordable price.

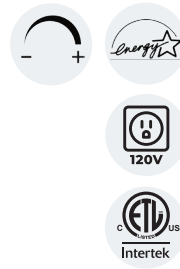

## FEATURES

- Elegant and energy efficient design
- Brushed nickel trim finish
- Input voltage 120V AC
- Dimmable with most ELV dimmers
- 50,000 hours life
- Suitable for damp location
- cETLus listed
- Easy installation
- Maintenance free
- Even light distribution
- 5 years warranty

## APPLICATIONS

- Hallways
- Lobbies
- Banquet halls
- Retail
- Restaurants

## SPECIFICATIONS

SPECIFICATIONS		
<b>Product Code</b>	WSL-15-XXK-BN	
<b>Electrical</b>	Input Voltage	120V AC
	Power Consumption	15W
<b>Specs</b>	Colour Temperature	3000K
	CRI	80+
	Lumen Output	1600LM
	Dimmable	Yes (with most ELV dimmers)
	Beam Angle	180°
<b>LED</b>	Life Span	50,000 Hours
<b>Design</b>	Dimensions (Inches)	9.45 x 10.63"
	Dimensions (Millimeters)	240.03 x 270mm
	Finish Colour / Trims	Brushed Nickel
	Product Material	Metal/acrylic
	Approved Location	Indoor
	Mounting	Wall
<b>Warranty</b>		5 years
<b>Approvals</b>		cETLus and Energy Star

## PRODUCT CODES

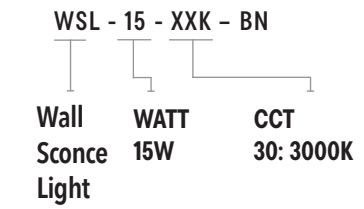

## DIAGRAM

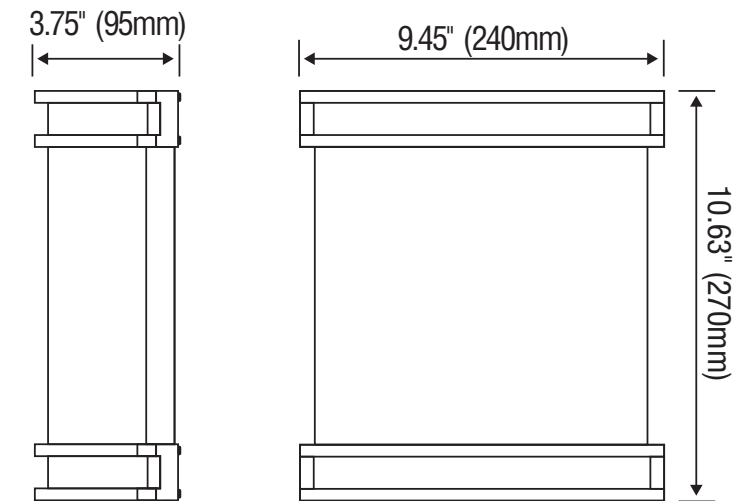

# T-Edge Lights (5CCT)

An innovative lighting solution, ideal for general and accent lighting in offices, hallways, and commercial applications. Its edge-lit design and 5CCT feature ensure versatile illumination, moving beyond traditional flat panels and troffers.

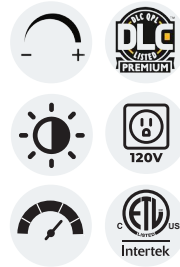

## FEATURES

- Ideal replacement for traditional flat panel and troffers
- Non-flicker, no dark spots
- IP Rating: IP40
- cETLus and DLC premium listed
- Dry locations
- 5 year limited warranty

## APPLICATIONS

- |                    |                   |
|--------------------|-------------------|
| <b>RESIDENTIAL</b> | <b>COMMERCIAL</b> |
| • Kitchens         | • Retail          |
| • Bathrooms        | • Offices         |
| • Laundry rooms    | • Hallways        |
| • Pantries         | • Elevators       |
| • Rec rooms        | • Banquet halls   |
|                    | • Restaurants     |

SPECIFICATIONS		
Product Code	TLE-2X2-K40-3065	TLE-2X4-K60-3065
<b>Electrical</b>	Input Voltage	100-277V AC
	Power Consumption	20/30/40W Adjustable
<b>Specs</b>	Colour Temperature	3000/3500/4000/5000/6500K
	CRI	80+
	Lumen Output	2500-5000LM
	Efficacy (LM/W)	130
	Dimmable	0-10V Dimming
	Beam Angle	120°
<b>LED</b>	Life Span	50,000 Hours
<b>Design</b>	Dimensions (Inches)	23.74 x 23.74 x 0.59"
	Dimensions (Millimeters)	603 x 603 x 15mm
	Finish	White
	Housing Material	6063-T5
	Operating Temperature	-20° to 45°C
	Approved Location	Dry
	Mounting	Ceiling (placed upon t-bar or hung with wire)
<b>Warranty</b>	5 years	
<b>Approvals</b>	cETLus and DLC Premium	

## PRODUCT CODES

TLE - 2X2 - K40 - 3065  
 TLE - 2X4 - K60 - 3065

SIZE                  WATTS

## DIAGRAM

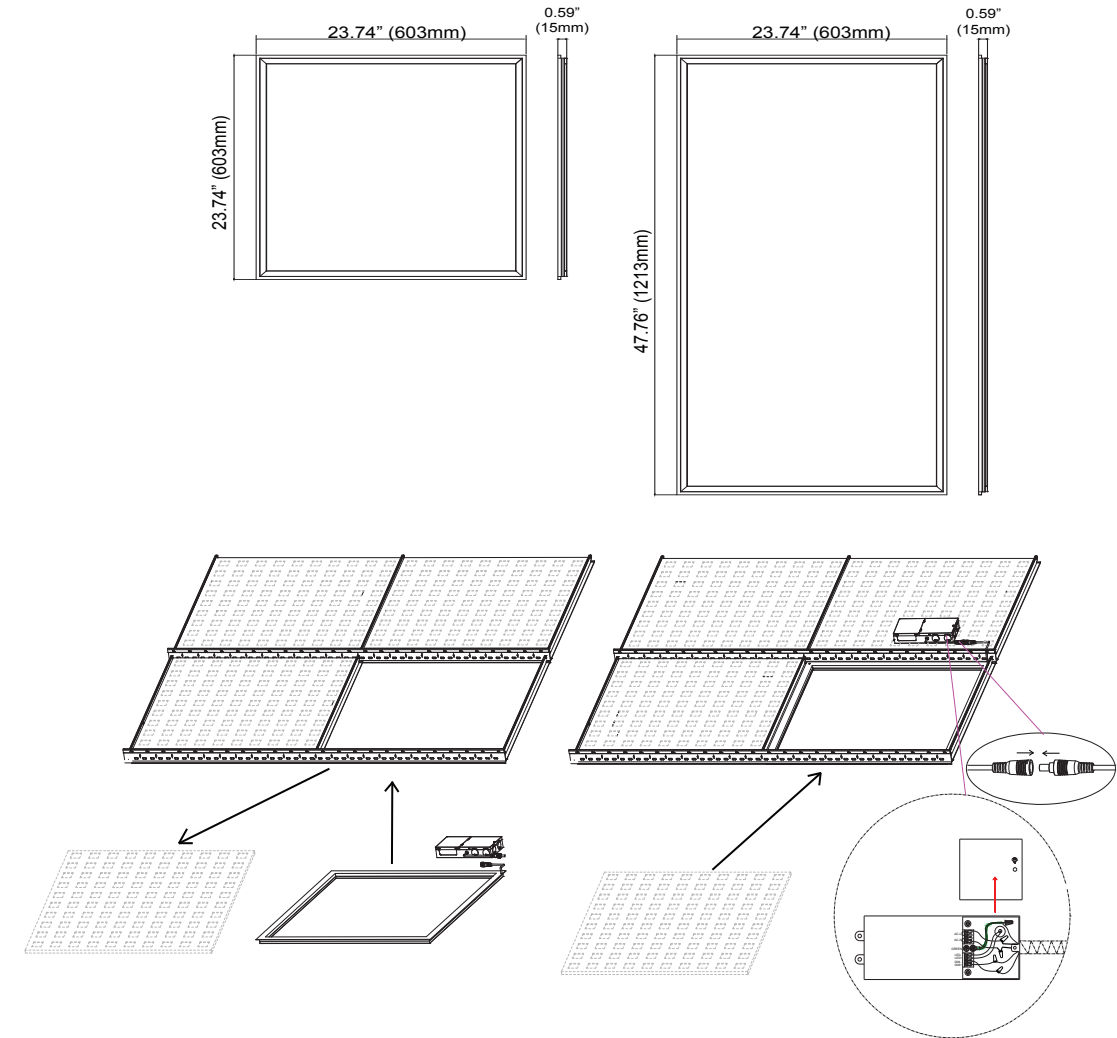

## ACCESSORIES



**TLE-DM**  
 Driver mount bracket (for mounting the bracket to the T-BAR)



**TLE-MC**  
 Mounting clips (for fixture wire suspension)



**ELP14-2060-UNV**  
 Emergency Driver (sold separately)

### NOTES:

- TLE-EX-CCT-10: T-LED CCT Edge Light Extension Cord. 10ft is available.
- Driver mount bracket (TLE-DM), and mounting clips (TLE-MC) are available (sold separately). Please check your local building codes, if these accessories.



# 5CCT Fire Rated Thin Line

Designed to seamlessly merge into any environment, these fixtures combine sleek aesthetics with top-tier fire-resistant materials, ensuring not only captivating illumination but also adherence to stringent safety standards. Illuminate spaces with confidence, knowing you've chosen the best in style and safety.



## FEATURES

- 2 hour fire rated: UL 263, ASTM E119 & CAN/ULC S101-14
- Two spring loaded clips to attach to any ceiling material
- White finish (interchangeable brushed nickel, black, oil-rubbed bronze, and copper trim rings available – sold separately)
- Wet locations listed
- No IC can required, for direct contact with insulation and combustible materials
- Optional 347V step-down
- 5 year limited warranty
- Airtight
- cETLus and Energy Star listed
- Comes with mounting brackets and end-to-end connector

## APPLICATIONS

- Kitchens & pantries
- Laundry rooms
- Bathrooms
- Lobbies & hallways
- Banquet halls
- Elevators
- Retail lighting
- Offices & restaurants

## SPECIFICATIONS

Product Codes		DL-FR-5CCT-4-WH	DL-FR-5CCT-6-WH
Electrical	Input Voltage	120V AC	
	Output Power (W)	12W	15W
Specs	Colour Temperature	5-position switch for colour temperature adjustment: 2700/3000/3500/4000/5000K	
	CRI	90+	
	Lumens	800LM	1100LM
	Efficacy (LM/W)	73	
	Dimmable	Yes, with TRIAC dimmers	
	Beam Angle	120°	
LED	Type	Epistar	
	Life Span	50,000 Hours	
Design	Dimensions (Inches)	D1=3", D2=5", H=1/2"	D1=5", D2=7", H=1/2"
	Dimensions (Millimeters)	D1=81mm, D2=127mm, H=11.5mm	D1=126mm, D2=175mm, H=11.5mm
	Finish	White finish	
	Trim Ring (Finish)	Brushed nickel, black, oil-rubbed bronze, and copper trim rings – Sold separately	
	Operating Temperature	-20° to 45°C	
	Approved Location	Wet	
	Mounting	Ceiling	
Warranty	5 years		
Approvals	cETLus and Energy Star		



## DIAGRAM

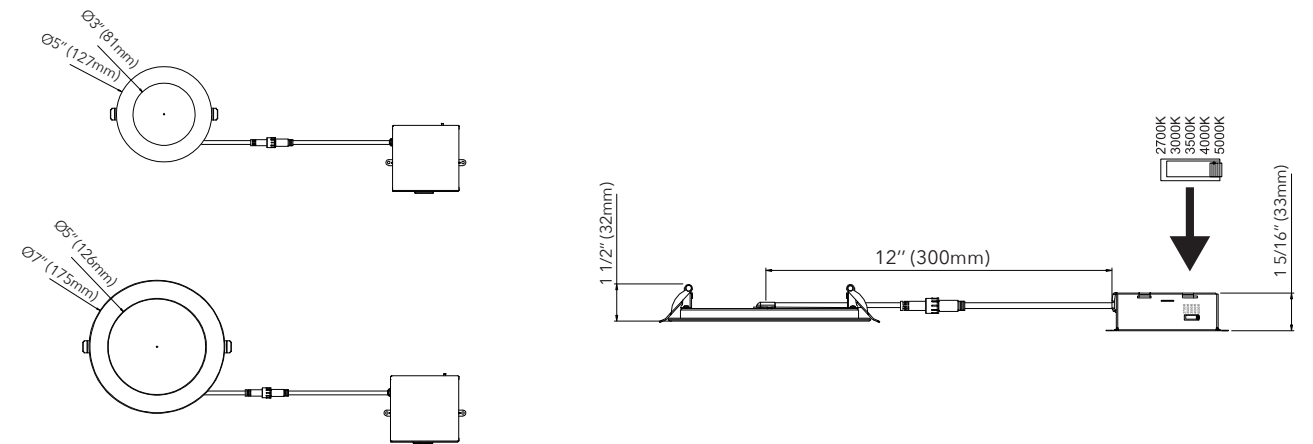

## ACCESSORIES



**DL-FR-TR-4-YY**  
TRIM RINGS  
YY=  
• BK (Black)  
• BZ (Oil Rubbed Bronze)  
• BN (Brushed Nickel)  
• CP (Copper)



**DL-FR-TR-6-YY**  
TRIM RINGS  
YY=  
• BK (Black)  
• BZ (Oil Rubbed Bronze)  
• BN (Brushed Nickel)  
• CP (Copper)



**DL-FR-BR-4**  
BEAUTY RINGS



**DL-FR-BR-6**  
BEAUTY RINGS



**DL-FR-CP-4**  
CONSTRUCTION PLATES



**DL-FR-CP-6**  
CONSTRUCTION PLATES





# Industrial Lighting



# Tri-Proof Lights

Tri-Proof Lights are robust and stylish, designed to withstand impacts, dust, and water, making them suitable for tough environments like factories and garages, as well as residential areas like stairwells and hallways.



## FEATURES

- Water-proof (IP66), dust-proof, pressure-proof (IK10)
- Luminous Efficacy (LPW): 110-120
- Available in 4 ft. length / 40W version
- Excellent heat dissipation
- 50,000 hours life
- Energy efficient: Up to 80% energy savings
- Vandal resistant
- cETLus listed
- 5 years limited warranty

## APPLICATIONS

- Parking garages
- Tunnels
- Airports
- Exhibition halls
- Railway, bus and subway stations
- Warehouses and factories
- Supermarkets
- Schools

## SPECIFICATIONS

Product Code		SL66-4FT-40W-40
Electrical	Input Voltage	100-240V/277V
	Power Efficiency	90%
Specs	Colour Temperature	4000K
	CRI	80+
	fficacy	110-120LM/W
	Dimmable	No
	Beam Angle	120°
LED	Type	High brightness SMD2835
	Life Span	50,000 Hours
Design	Dimensions (Inches)	48 x 3.7 x 2.7"
	Dimensions (Millimeters)	1200 x 94 x 69mm
	Operating Temperature	-22°F to 113°F (-30°C to 45°C)
	Approved Location	Indoor/Outdoor
	Mounting	Ceiling via brackets
Warranty		5 years
Approvals		cETLus

NOTE: Each fixture ships with two strain relief connectors.

## PRODUCT CODES

SL66 - 4FT - 40W - XX



Tri-Proof Light



LED COLOUR

40: 4000K

## DIAGRAM

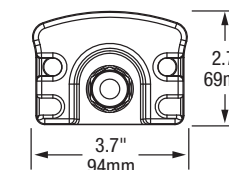
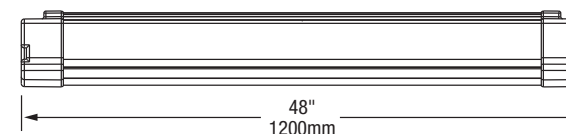

Surface Ceiling Mounting (Standard)

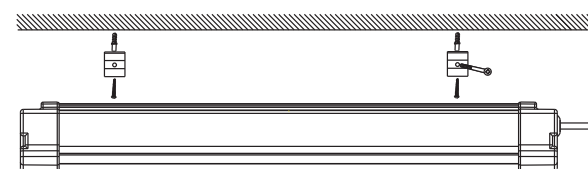

Swivel Mount Kit (Part# SL66-AD-MC) Sold Separately

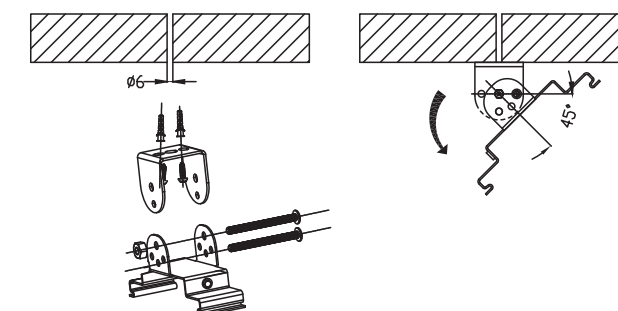

Suspended Mounting (Suspension Kit - Part# SL66-Sus-Kit) Sold Separately

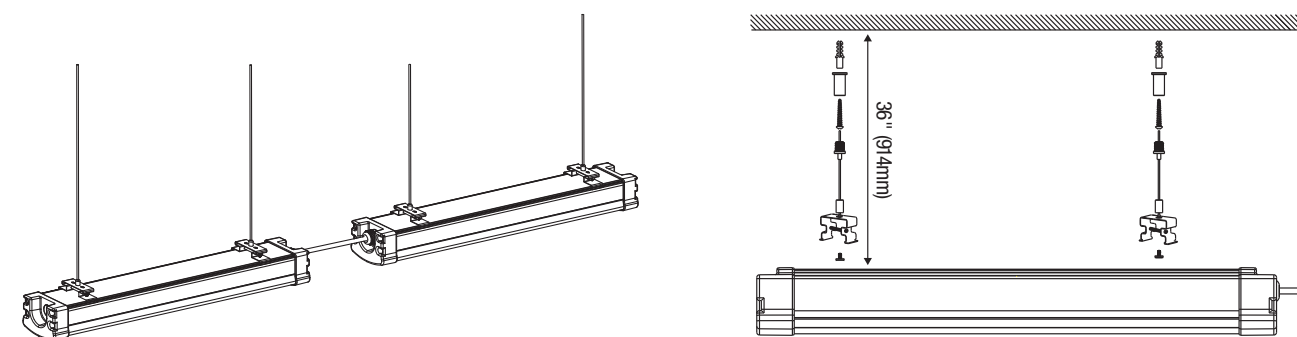



# 100W LED Work Light

The LED Work Light is an energy savings, impact resistant long life temporary lighting solution for illuminating workplaces, shops, garages, and warehouses.



## FEATURES

- Spring loaded hook
- 10ft power cord with plug
- 6KV/10KV surge protection
- Hidden, built-in hidden socket
- Eye-catching housing
- Stainless steel guard
- Epistar LEDs
- Hollow heat sink
- Silicone gaskets for damp location use
- 5 years limited warranty

## APPLICATIONS

- Construction sites
- Machinery illumination
- Automotive garages
- Industrial warehouses
- Repair shops
- Outdoor night projects

## SPECIFICATIONS

Product Code	LWL-100W-50	
<b>Electrical</b>	Input Voltage	120V AC, 50-60Hz
	Power Consumption	60W
<b>Specs</b>	Colour Temperature	5000K
	CRI	80+
	Lumen Output	13,500 Lm
	Efficacy	135 LM/W
	Beam Angle	360°
<b>LED</b>	Type	Epistar 2835
	Life Span	50,000 Hours
	# per foot / unit	408
<b>Design</b>	Dimensions (Inches)	6.5 x 11.5"
	Dimensions (Millimeters)	165 x 292mm
	Finish Colour / Trims	Black, yellow
	Product Material	Stainless steel guard
	Max Single Run Length	10 LED work lights
	Operating Temperature	-20°C to 40°C
	Approved Location	Damp
	Mounting	Optional tripod, floor mount, magnet mount accessories
<b>Warranty</b>	5 years	
<b>Approvals</b>	cULus, listed for damp location	

## PRODUCT CODES

LWL - 100W - 50

## DIAGRAM

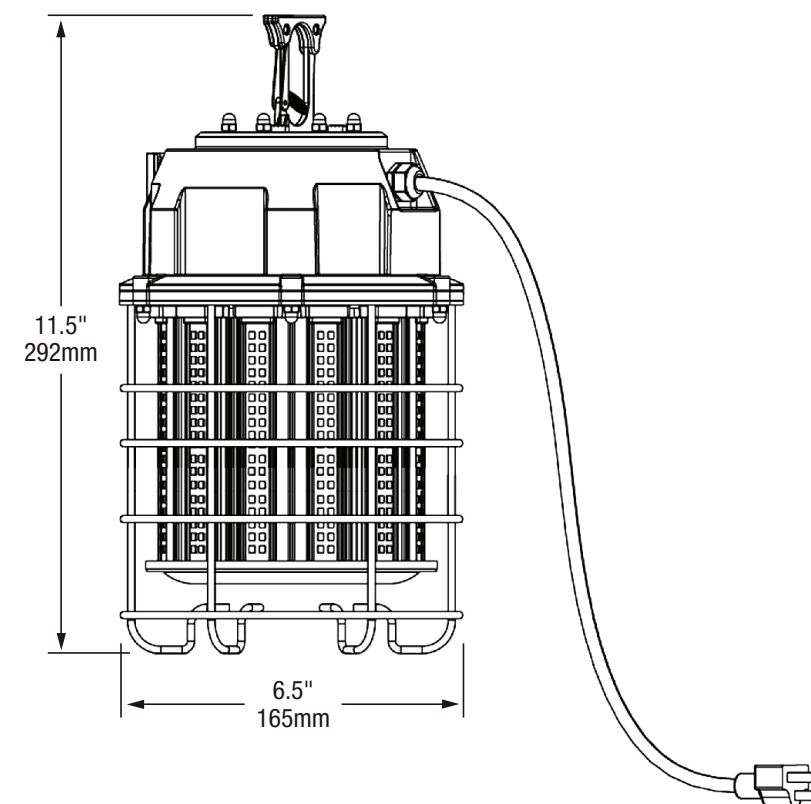

## ACCESSORIES



**LWL-MM**  
Magnet mount kit



**LWL-FM**  
Floor mount kit



**LWL-TM**  
Tripod mount kit

# 60W LED Work Light

The 60W LED Work Light offers energy-saving, impact-resistant, long-life, temporary lighting solutions for illuminating construction sites, shops, garages, and warehouses.



## FEATURES

- 5ft power cord with plug
- Lumen output: 7200LM
- Built-in hidden socket
- Up to 10 LED Work Lights per 120V AC tap
- Stainless steel guard
- LED colour: 5000K
- Damp locations
- 5 years limited warranty
- Optional tripod, floor mount and magnet mount accessories

## APPLICATIONS

- Construction sites
- Workshops
- Garages
- Warehouses
- Outdoor night projects
- Emergency repair situations

## SPECIFICATIONS

Product Code	LWL-60W-50	
Electrical	Input Voltage	120V AC, 50-60Hz
	Power Consumption	60W
Specs	Colour Temperature	5000K
	CRI	80+
	Lumen Output	7200
	Efficacy	120 LM/W
	Beam Angle	360°
LED	Type	Epistar 2835
	Life Span	50,000 Hours
	# per foot / unit	408
Design	Dimensions (Inches)	5.12"W x 10.4"H
	Dimensions (Millimeters)	130mm x 215mm
	Finish Colour / Trims	Black, yellow
	Product Material	Stainless steel guard
	Max Single Run Length	10 LED work lights
	Operating Temperature	-20°C to 40°C
	Approved Location	Damp
	Mounting	Optional tripod, floor mount, magnet mount accessories
Warranty	5 years	
Approvals	cETLus and DLC	

## PRODUCT CODES

LWL - 60W - 50

## DIAGRAM

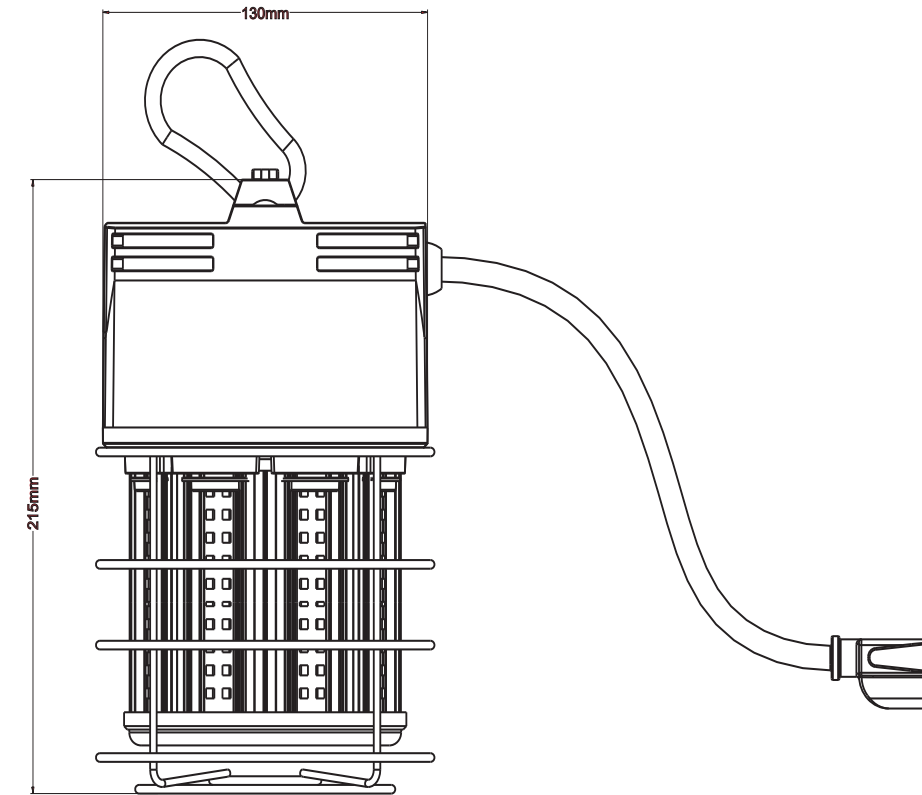

## ACCESSORIES



**LWL-MM**  
Magnet mount kit



**LWL-FM**  
Floor mount kit



**LWL-TM**  
Tripod mount kit

# LED String Work Light

The LED String Work Light features 5 x 8-watt LED fixtures along a 50Ft string, offering bright, efficient, and portable lighting for construction sites, shops, garages, or warehouses.



## FEATURES

- Length: 50ft
- Lumen output: 5000LM
- Wet locations
- LED colour: 5000K
- 40 Watts per string
- Up to 10 LED string work lights per 120V AC tap

- Metal wire guard around each fixture
- Carabiner clip on each fixture
- 5 years limited warranty

## APPLICATIONS

- Construction sites
- Outdoor events
- Workshops
- Garages
- Warehouses
- Marinas

## SPECIFICATIONS

Product Code	SWL-60W-50	
Electrical	Input Voltage	120V AC, 50-60Hz
	Power Consumption	60W
Specs	Colour Temperature	5000K
	CRI	80+
	Lumen Output	7500
	Efficacy	112.5 LM/W
	Beam Angle	180°
LED	Type	Epistar 2835
	Life Span	50,000 Hours
	Spacing	1500mm (59 1/16") at start/finish, 4 x 3000mm (118 7/64")
	# per foot / unit	5
Design	Dimensions (Inches)	4.5" W x 3" H
	Dimensions (Millimeters)	112 x 78mm
	Finish Colour / Trims	Yellow
	Max Single Run Length	50Ft
	Operating Temperature	-20°C to 40°C
	Approved Location	Wet
	Mounting	Carabiner clip
Warranty	5 years	
Approvals	cETLus	

## PRODUCT CODES

SWL - 60W - 50

## DIAGRAM

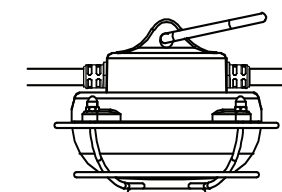
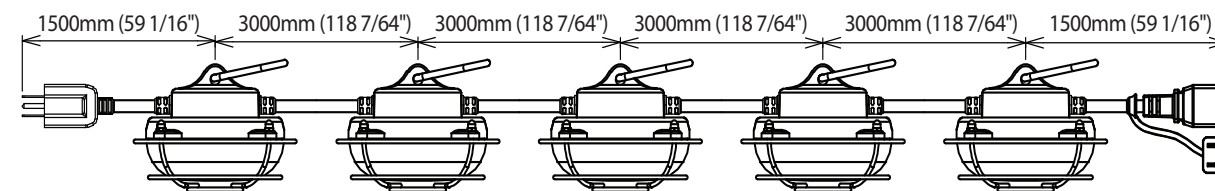



The background features a series of diagonal stripes in shades of light blue, white, and pale yellow. Two overlapping circles are positioned on the right side: a larger one in the upper right and a smaller one below it, both with a blue-to-teal gradient.

# Drivers & Controllers

# Switchex®

## LED DRIVER + DIMMER IN ONE

SWITCHEX® is a dimmer with an integrated driver that converts 120VAC to either 12VDC or 24VDC. This means SWITCHEX® is all you need between your line voltage and low voltage LED lighting. Best of all, it fits in a standard electrical box.

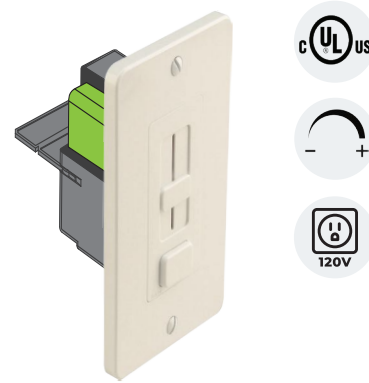

SWITCHEX® solves two of the most common LED lighting challenges:

- Poor dimming performance that often results when a dimmer and LED driver are made by different manufacturers
- Finding a place to fit the LED driver



### FEATURES

- First LED Driver + In-Wall Dimmer Switch in one unit
- Simplifies LED installation by eliminating compatibility issues between driver and dimmer
- Fits in a standard recessed electrical box
- 100% - 1% smooth dimming
- No minimum load
- Single pole preset dimmer with on/off push switch
- Adjustable voltage output dial to address voltage drop
- Includes voltage barrier partition to install high and low voltage circuit in same switch box
- No derating required when ganging units
- Power failure memory: If power is interrupted, SWITCHEX will return to setting prior to interruption

### APPROVED FIXTURES

- 24V LED Fixtures
- HP strip series
  - eStrip
  - Globe light
  - Hard strip
- 12V LED Fixtures
- Disc light

SPECIFICATIONS			
Product Code		SX-12V-DD-60W	SX-24V-DD-100W
Electrical	Input Voltage	120V AC	
	Output Voltage	12V DC	24V DC
Specs	Max. Load	60W, 5A	100W, 4.2A
	Power Factor	>0.9 @ 120VAC 60Hz max load	
	Efficiency	≥91% @ 120VAC max load	
	Dimmable	Yes	
	Protections	Short circuit, thermal runaway, and over voltage	
	Mounting	Single-Gang Box	
	Connection Type	Hardwire	
Warranty	2 years		
Approvals	cULus, FCC, RoHS		

### PRODUCT CODES

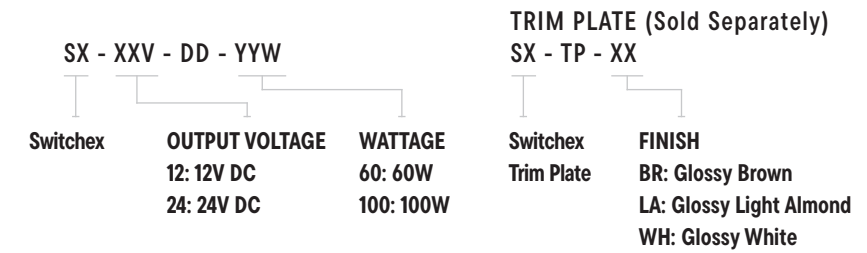

### DIAGRAM

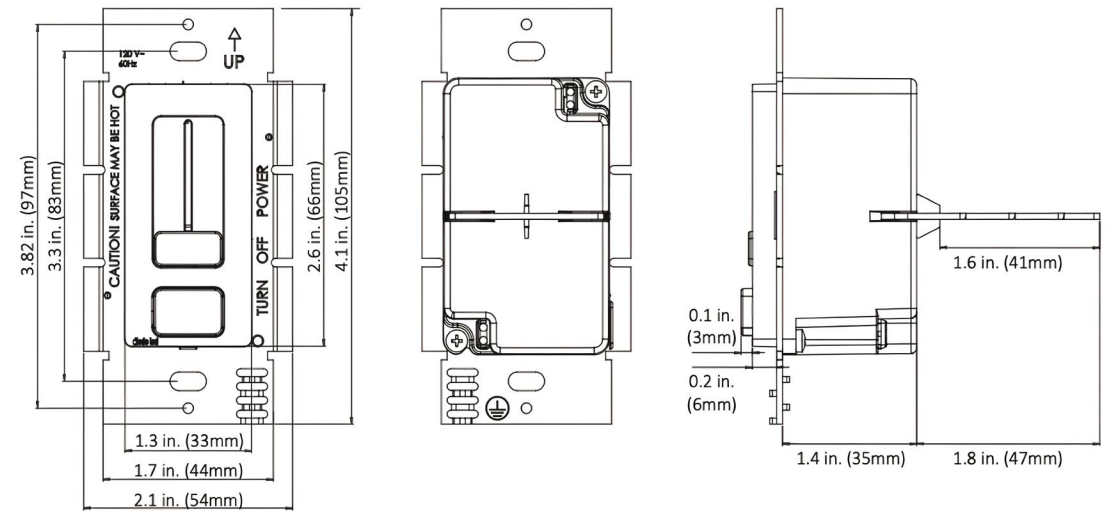
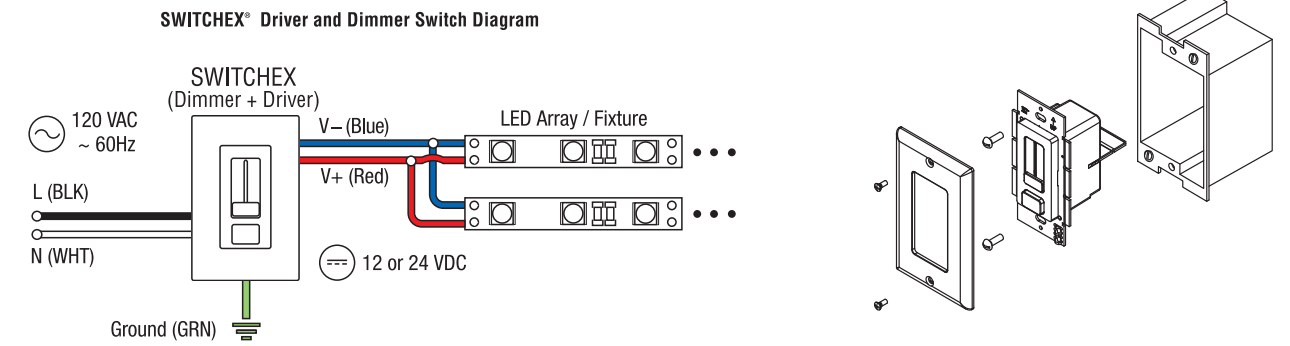

### The Driver Is Inside

SWITCHEX® is all you need between your line voltage and low voltage LED lighting. The integrated driver converts 120VAC to either 12VDC or 24VDC and it fits in a standard electrical box.

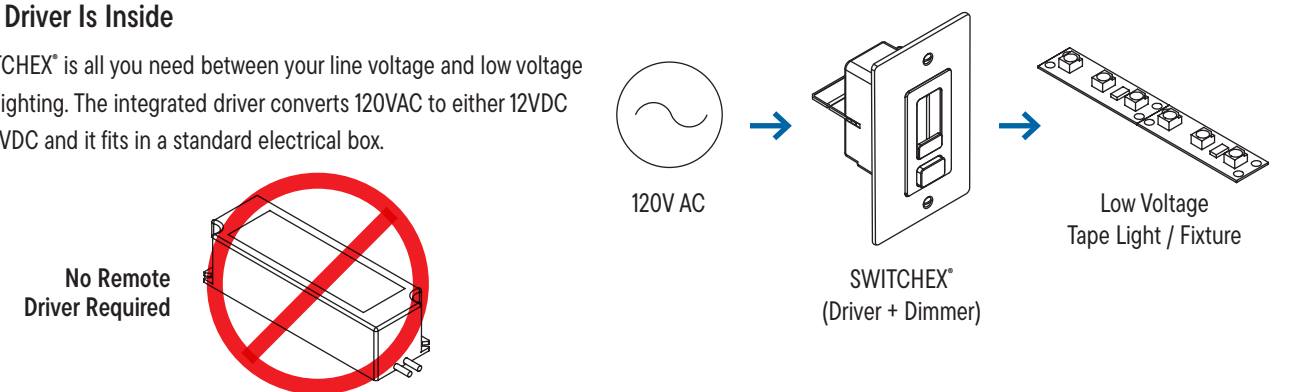

# Dimmable Driver/Dimmer Compatibility List

Our dimmable LED drivers offer smooth brightness control, letting you adjust your LED lighting from fully lit (100%) to completely off (0%). These drivers are Class 2 certified and built to work with the majority of standard Magnetic Low Voltage (MLV) and Incandescent TRIAC (leading edge) dimmers. Trusted brands like Lutron and Leviton, prevalent in both residential and commercial settings, are compatible with our drivers, ensuring broad availability and ease of integration.

**Note:** Compatibility list may change without prior notice.

DIMMER COMPATIBILITY LIST				
DIMMER TYPE - LISTED	MLDRE-96-24-DM	MLDRE-40-24-DM	MLDRE-60-12-DM	MLDRE-20-12-DM
Lutron Caseta, Wireless PD-6WCL (MLV)	Dims to 0%	Dims to 0%	Dims to 0%	Dims to 0%
Lutron Maestro, Wireless MRF-2-6CL (MLV)	Dims to 1%	Dims to 1%	Dims to 1%	Dims to 1%
Lutron Radio RA2 RRD-6ND (MLV)	Dims to 0%	Dims to 0%	Dims to 0%	Dims to 0%
Lutron Maestro MA-600 (MLV)	Dims to 0%	Dims to 0%	Dims to 0%	Dims to 0%
Leviton Decore Smart DW6HD (MLV)	Dims to 0%	Dims to 0%	Dims to 0%	Dims to 0%
Lutron Nova T NTLV-600 (MLV)	Dims to 1%	Dims to 1%	Dims to 1%	Dims to 1%
Lutron Diva DVLV-600P (MLV)	Dims to 0%	Dims to 0%	Dims to 0%	Dims to 0%
Lutron Diva DVLV-103P (MLV)	Dims to 0%	Dims to 0%	Dims to 0%	Dims to 0%
Lutron Caseta, Wireless PD-10NXD	Dims to 0%	Dims to 0%	Dims to 0%	Dims to 0%
Lutron Maestro MA-PRO (MLV Mode)	Dims to 0%	Dims to 0%	Dims to 0%	Dims to 0%
Lutron Radio RA2 RRD-PRO (MLV Mode)	Dims to 1%	Dims to 1%	Dims to 1%	Dims to 1%
Lutron Caseta, Wireless PD-5NE (MLV Mode)	Dims to 0%	Dims to 0%	Dims to 0%	Dims to 0%
Lutron Caseta, Smart Home Plug-in PD-3PCL	Dims to 0%	Dims to 0%	Dims to 0%	Dims to 0%
Lutron Maestro MACL-153P	Dims to 0%	Dims to 0%	Dims to 0%	Dims to 0%
Lutron Maestro MSC-1000M	Dims to 0%	Dims to 0%	Dims to 0%	Dims to 0%
Lutron Toggle TGCL-153P	Dims to 0%	Dims to 0%	Dims to 0%	Dims to 0%
Lutron Sunnata Touch STCL-153P	Dims to 0%	Dims to 0%	Dims to 0%	Dims to 0%
Leviton Decora Smart DW1KD-1BZ	Dims to 0%	Dims to 0%	Dims to 0%	Dims to 0%
Leviton Decora Digital DDMX1-BLZ	Dims to 1%	Dims to 1%	Dims to 1%	Dims to 1%
Leviton Decora Slide DSM10	Dims to 1%	Dims to 1%	Dims to 1%	Dims to 1%
Leviton Decora Slide DSL06-1LZ	Dims to 0%	Dims to 0%	Dims to 0%	Dims to 0%
GE Z-Wave Plus ZW3005	Dims to 0%	Dims to 0%	Dims to 0%	Dims to 0%
WeMo WiFi F7C059	Dims to 0%	Dims to 0%	Dims to 0%	Dims to 0%
TP-Link Kasa Smart HS220P3	Dims to 0%	Dims to 0%	Dims to 0%	Dims to 0%
Leviton Lumina RF DL1KD-1BZ (MLV)	Dims to 1%	Dims to 1%	Dims to 1%	Dims to 1%

# LED Drivers

An LED driver is a specialized electrical device that manages power for an LED or groups of LEDs. Unlike standard power supplies, an LED driver adapts to the LED's changing requirements, ensuring it receives a consistent power supply as its electrical characteristics vary with temperature.

INDOOR NON-DIMMABLE DRIVERS	
<b>LEDDR-12-20W-HW</b>	LED Driver, 12V DC, 20W, hardwire, supplied in a junction box
<b>MLDR-20-24JB</b>	20W, 24V DC hardwire driver, supplied in a junction box

INDOOR/OUTDOOR NON-DIMMABLE DRIVERS	
<b>LEDDR-12-60W</b>	60W 12V DC, 5A Class 2 LED Driver, outdoor rated
<b>MLDR-120-24</b>	120W, 24V DC 2 circuits at 60W, outdoor rated hardwire driver

INDOOR/OUTDOOR DIMMABLE DRIVERS	
<b>MLDRE-20-12-DM</b>	Electronic LED Driver 20W, 12V DC, IP rated, dimmable
<b>MLDRE-60-12-DM</b>	Electronic LED Driver 60W, 12V DC, IP rated, dimmable
<b>MLDRE-40-24-DM</b>	Electronic LED Driver 40W, 24V DC, IP67 rated, dimmable
<b>MLDRE-96-24-DM</b>	Electronic LED Driver 96W, 24V DC, IP67 rated, dimmable
<b>E-KO-SR</b>	Wet Location Strain Relief for E Series Drivers, PG7, clamping range dia. 3-6.5mm



MLDR-20-24JB  
LEDDR-12-20W-HW



LEDDR-12-60W



MLDR-120-24



MLDRE-20-12-DM  
MLDRE-60-12-DM



MLDRE-40-24-DM  
MLDRE-96-24-DM



E-KO-SR



# LED Drivers Selector Chart

	Neon Flex	Strip Series†	Globe Light	Wedge Light
<b>INDOOR NON-DIMMABLE DRIVERS</b>				
LEDDR-12-20W-HW 12V, 20W, hardwire in junction box, Max. 20W	-	-	-	Max. 80 Globes
MLDR-20-24JB 24V, 20W, hardwire in junction box, Max. 20W	Max 7.3' (2.2m) LED Neon Flex	Max. recommended load 18W or 4' (1.22m) LED Strip Series 6' (1.83m) CCT Series	Max. 60 Globes	-
<b>INDOOR/OUTDOOR NON-DIMMABLE DRIVERS</b>				
LEDDR-12-60W 12V, 60W, hardwire, outdoor, Max. 60W	-	-	-	Max. 200 Globes
MLDR-120-24 24V, 120W, hardwire, outdoor, Max. 120W	Max 40' (12.1m) per single tap, Max 48' (14.6m) combined two secondary taps	Max. recommended load 90W or 20' (6.1m) per single tap, 120W or 27' (8.53m) combined two secondary taps. CCT series: 16' (4.88m) per single tap, 20' (6.1m) combined two secondary taps	Max. 180 Globes per single tap, max. 120 combined two secondary taps	-
<b>INDOOR/OUTDOOR DIMMABLE DRIVERS</b>				
MLDRE-20-12-DM** 12V, 20W, hardwire, outdoor, dimmable, Max. 18W, Min. 10W	-	-	-	Max. 80 Globes
MLDRE-60-12-DM** 12V, 60W, hardwire, outdoor, dimmable, Max. 54W, Min. 30W	-	-	-	Max. 200 Globes
MLDRE-40-24-DM** 24V, 40W, hardwire, outdoor, dimmable, Max. 36W, Min. 20W	Max 14.5' (4.4m) Min 8 watts, 3.3' (1m) LED Neon Flex	LED Strip Series: Max. recommended load 36W or 8' (2.44m), Min. 8W or 2' (.61m)	Max. 80 Globes	-
MLDRE-96-24-DM** 24V, 100W, hardwire, outdoor, dimmable, Max. 90W, Min. 50W	Max 40' (12.1m) Min 8 watts, 3.3' (1m) LED Neon Flex	LED Strip Series: Max. recommended load 90W or 20' (6.1m), Min. 8W or 2' (.61m)	Max. 180 Globes	-

	Hard Strip	eStrip	Disc Light	MiniDisc Light
<b>INDOOR NON-DIMMABLE DRIVERS</b>				
LEDDR-12-20W-HW 12V, 20W, hardwire in junction box, Max. 20W	-	-	Max. 6 LEDD	Max. 75 LEDMD
MLDR-20-24JB 24V, 20W, hardwire in junction box, Max. 20W	Max. recommended load 18W LED Hard Strip	Max. 18' (5.4m) LED eSTRIP Max. 8' (2.4m) HP LED eSTRIP	-	-
<b>INDOOR/OUTDOOR NON-DIMMABLE DRIVERS</b>				
LEDDR-12-60W 12V, 60W, hardwire, outdoor, Max. 60W	-	-	Max. 18 LEDD	Max. 200 LEDMD
MLDR-120-24 24V, 120W, hardwire, outdoor, Max. 120W	-	Max. 90' (27.43m) per single secondary tap, max. 120' (36.58m) combined two secondary taps. RGB eStrip & HP eStrip: 40' (12.1m) per single secondary tap, 50' (15.24m) combined secondary taps	-	-
<b>INDOOR/OUTDOOR DIMMABLE DRIVERS</b>				
MLDRE-20-12-DM** 12V, 20W, hardwire, outdoor, dimmable, Max. 18W, Min. 10W	-	-	Max. recommended load 18W or 6 LEDD Min. recommended load 8W or 3 LED Disc Lights	Max. 75 LEDMD Min. recommended load 8W or 34 LED MiniDisc Lights
MLDRE-60-12-DM** 12V, 60W, hardwire, outdoor, dimmable, Max. 54W, Min. 30W	-	-	Max. recommended load 54W or 18 LEDD Min. recommended load 8W or 3 LED Disc Lights	Max. 200 LEDMD Min. recommended load 8W or 34 LED MiniDisc Lights
MLDRE-40-24-DM** 24V, 40W, hardwire, outdoor, dimmable, Max. 36W, Min. 20W	Max. recommended load 36W, Min. 8W LED Hard Strip	LED eStrip: Max. 37.5' (11.43m), Min. 8W, 9' LED eStrip (2.44m). High Power: Max. 18' (5.49m), Min. 4' (1.2m)	-	-
MLDRE-96-24-DM** 24V, 100W, hardwire, outdoor, dimmable, Max. 90W, Min. 50W	Max. recommended load 90W, min. 8W LED Hard Strip	LED eSTRIP: Max. 90' (27.4m), Min. 8W, 9' LED eStrip (2.44m). High Power: Max. 40' (12.19m), Min. 4' (1.2m)	-	-

† NOTE: Above maximum and minimum lengths are for LP-5060-60 series. You may double these when using LP-5060-30 series)

\*\* MLDRE drivers require E-KO-SR for outdoor applications



# LED Controllers List

The selection includes a PIR Motion Sensor for 12/24V DC systems, facilitating energy-efficient, motion-activated lighting. The lineup features WiFi Signal Amplifiers and Controllers, compatible with RGB, RGBW, and CCT setups, ensuring robust signal strength and versatile light management. Additional offerings include a remote control for the WiFi system, an outdoor-rated RGB signal amplifier, and an RF mini controller with an extension cable for LED Hard Strips. For tactile control, there is an RF Touch Control for RGBW lighting, alongside a Signal Amplifier designed for RGB-W systems, catering to both indoor and outdoor lighting scenarios.

Product	Description
<b>SENSORS</b>	
LV-SPIR-1CH-LV	PIR Motion Sensor, 1 Channel, 12/24V DC
<b>CONTROLLERS &amp; AMPLIFIERS</b>	
LT-WIFI-AMP	WiFi Signal Amplifier for RGB, RGBW, CCT
LT-WIFI-CTRL	WiFi Controller for RGB, RGBW, CCT
LT-WIFI-RM	Remote for LT-WIFI-CTRL
LV-RF103	Wireless RF mini RGB controller 24V, 96W
LV-RF103-EXHS	6" RF Extension Cable, for RGB LED Hard Strip
LT-11S-RF	RF Touch Control controller for RGBW
LT-490A	Signal Amplifier for RGB-W 12/24V DC



LV-SPIR-1CH-LV



LT-WIFI-AMP



LT-WIFI-CTRL



LT-WIFI-RM



LV-ZJFFS-3CH-6INW



LV-RF103



LV-RF103-EXHS



LT-11S-RF



LT-490A





**Tokistar  
Lighting**



# Tokistar Lighting

Tokistar lighting products are innovative and energy-efficient solutions for a range of applications, including architectural, decorative, and specialty lighting. Designed for both indoor and outdoor use, these are known for their flexibility, durability, and ability to enhance the aesthetic of any space.

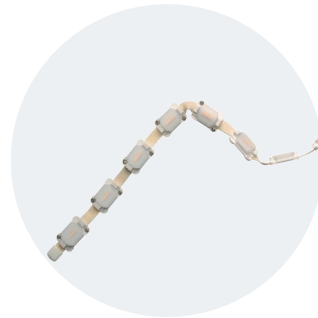

### Advantage

Flexible LED cove and indirect lighting with a dim-to-warm option.



### Cable Lighting

Compact luminaires easily incorporated into confined spaces for soft and uniform illumination.

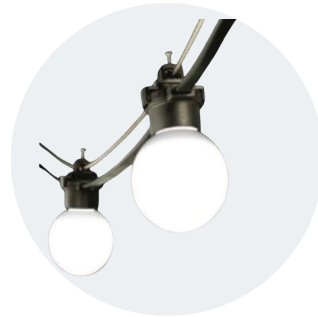

### Exhibitor

All environment festoon lighting with clear, frosted and colored globes.



### Focal Series

Compact luminaires easily incorporated into confined spaces for soft and uniform illumination.



### Gradient

Highly efficient LED luminaire for use in wall gazing and other interior lighting applications.



### Gradient GRX

High-output luminaire for exterior wall gazing.



### Gradient GRHB

High-output luminaire for interior wall gazing.



### KromaStar

A lighting innovation featuring 4-in-1 RGBW LEDs for consistent mixed color. Each LED consumes 0.96 watts at full brightness.



### Light Veil

Interior wall grazer with asymmetrical optics for surface and recessed applications.

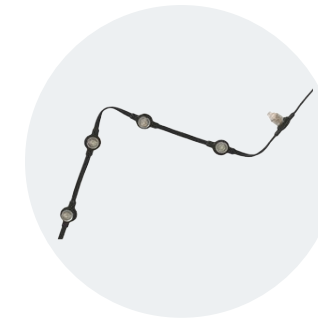

### Lightstrings

a system of sockets wired in parallel and permanently attached to flexible, commercial-grade wiring.



### Reveler

An indirect LED lighting fixture, that is ideal for illuminating building facades and other exterior & interior surfaces. It is wet-location listed with an IP66 rating.

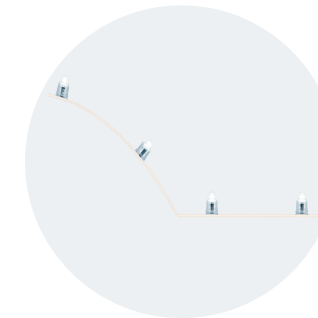

### Tapelight

All environment flexible lighting fixtures for a wide range of indirect and point-source applications.



### TokiLum

It uses high-output LEDs to provide an indirect wash of light on building facades, underneath step-nosings and from within very shallow ceiling coves.



### TokiLux

A compact high-performance LED luminaire for use within tight architectural details and in a variety of casework and shelf conditions.



### TokiLux WG

TokiLux Wall Grazer is TokiLux fitted with an optics package making the system ideal for use as a wall-grazing luminaire.



### Trillium

Low profile and all environment lighting, available in a variety of color temperatures and RGB

# Appendix

	Sub-Category	Lighting Solution	Technical Details	Page
Linear Lighting	Strip Series	High Density, High Power Indoor	24V; 5.8W/FT; 3000/4000/6500K; 16' MAX RUN; OUTPUT: 450-514 LM/FT	6
		High Density, Low Power Indoor	24V; 2.9W/FT; 3000/4000/6500K; 31' MAX RUN; OUTPUT: 225-257 LM/FT	8
		CCT Indoor	24V; 5.8W/FT; 2500-7000K. 16' MAX RUN; OUTPUT: 261-383 LM/FT.	10
		COB Indoor	24V; 4.2W/FT; 2700/3000/3500/4000/6500K; 20' MAX RUN; OUTPUT: 315-374 LM/FT	12
		Dim to Warm	24V; 5.5W/FT; 1800-3000K; 16' MAX RUN; OUTPUT: 449LM/FT	14
		High Efficacy Indoor	24V; 5.1W/FT; 2700/3000/3500/4000/6500K; 16' MAX RUN OUTPUT: 508-586 LM/FT	16
		High Power Indoor	24V; 4.3W/FT; 2700/3000/3500/4000/6500K; 20' MAX RUN OUTPUT: 280-325 LM/FT	18
		High Power Outdoor	24V; 4.3W/FT; 2700/3000/3500/4000/6500K; 20' MAX RUN OUTPUT: 280-325 LM/FT	20
		High Power, RGB Indoor	24V; 4.3W/FT; RGB; 20' MAX RUN	22
		High Power, RGB Outdoor	24V; 4.3W/FT; RGB; 20' MAX RUN	24
		High Power, RGBW Indoor	24V; 4.3W/FT; RGB + 3000/4000/6500K; 20' MAX RUN	26
		Low Power Indoor	24V; 2.2W/FT; 2700/3000/3500/4000/6500K; 40' MAX RUN; OUTPUT: 143-165 LM/FT	28
		Low Power Outdoor	24V; 2.2W/FT; 2700/3000/3500/4000/6500K; 40' MAX RUN; OUTPUT: 143-165 LM/FT	30
		Low Power, RGB Indoor	24V; 2.2W/FT; RGB; 40' MAX RUN	32
		Low Power, RGB Outdoor	24V; 2.2W/FT; RGB; 40' MAX RUN	34
		Extrusions	-	36
		120V eStrip	120V eStrip	120V AC; 4W/FT; 2700/3000/4000K; 164' MAX RUN; OUTPUT: 280-340 LM/FT
	eStrip	Low Power eStrip	24V; 0.96W/FT; AMBER, RED, PURE GREEN; 3000/5800K. 90' MAX RUN; OUTPUT: 55-61 LM/FT	40
		High Power eStrip	24V; 2.2W/FT; 3000/5800K; 40' MAX RUN; OUTPUT: 137-155 LM/FT	42
		RGB eStrip	24V; 2.2W/FT; RGB; 40' MAX RUN	44
	Neon Flex	Neon Flex	24V; 2.44W/FT; RED, GREEN, BLUE, AMBER; RGB; 3000/4000/6000K; 40' MAX RUN; OUTPUT: 61LM/FT	46
	String Lights	Globe Light	24V; 0.5W; 2700/6000K; RED, GREEN, BLUE, AMBER; 150' MAX RUN; OUTPUT: 50 LM/FIXTURE	48
		Wedge Light	12V; 25W/Ft; AMBER; RED; GREEN; 2700/6000K. 100' MAX RUN; OUTPUT: 55-61 LM/FT	50
	Wall Washer	24V Wall Washer	24V; 5.8W/FT; 2700/3000/4000K; 16' MAX RUN; OUTPUT: 100-110 LM/FT	52
		Wall Washer 4' Enclosed	24V; 23.2W; 2700/3000/4000K; OUTPUT: 400-440LM	54

	Sub-Category	Lighting Solution	Technical Details	Page			
Under Cabinet Lighting	-	5CCT LED Task Bar	120V AC. 3.5W-20W; 2700/3000/3500/4000/5000K; OUTPUT: 290-1892LM	58			
		Gen II LED Hard Strip	24V; 4W-16W; 3000/4200K; OUTPUT: 380-1150 LM/FIXTURE	60			
		Gen II 3-Colour Change LED Task Star	120V AC; 5W-25W; 3000/4000/5000K; OUTPUT: 310-1500LM	62			
		LED Task Star Pro	120V AC; 3W-20W; 2700/3300/4000K; OUTPUT: 150-1000LM	64			
		LED Edgelit Puck Lights	24V; 4W; 3000K; OUTPUT: 200LM	66			
		LED Hard Strip RGB	24V; 3.6W-12W; RGB.	68			
		Flood and Spot Lights	-	Uplight (Wattage Adjustable)	12V; 0-12W; 3000K; OUTPUT: 900LM	72	
Uplight (RGBW)	12V; 0-8W; RGBW; OUTPUT: 500LM			74			
12V Mini Flood Light	12V; 1-5W; 3000K; OUTPUT: 400LM			76			
120V Mini Flood Light (CCT)	120V AC; 15-50W; 3000/4000/5000K; OUTPUT: 1750-7000LM			78			
Pathway Lights	-		Modern Pathway Light	12V; 1-3W; 3000K; OUTPUT: 80-240LM	80		
			Round Tea-Hat Pathway Light	12V; 1-3W; 3000K; OUTPUT: 80-240LM	82		
			HD Classic Pathway Light	12V; 5W; 3000K; OUTPUT: 400LM	84		
			Commercial Bollards	120V-347V AC; 8W-25W; 3000/4000/5000K; OUTPUT: 1000-3125LM	86		
			Wall and Deck Lights	-	Surface Mount Deck Light	12V; 1-3W; 3000K; OUTPUT: 60-180LM	88
					Outdoor Wall Sconce	120V-240V AC; 15W; 3000/4000K; OUTPUT: 1300LM	90
Brick Star (GEN II)	120V AC; 5.2W; 3000K; OUTPUT: 468LM	92					
Step Star (GEN II)	120V AC; 5.2W; 3000K; OUTPUT: 468LM	94					
Switch Star	120V AC; 1.4W; 2700K; OUTPUT: 80LM	96					
In Ground Lights	-	Disc Light			12V; 3W; 2700/5500K; AMBER; OUTPUT: 95-98LM	98	
		Mini Disc Marker Light	12V; 0.24W; 2900/5400K; BLUE, GREEN, AMBER, RED	100			
		Mini Disc Light (Scoop)	12V; 0.24W; 2900/5400K; BLUE, GREEN, AMBER, RED	102			
		Disc Light Dome	12V; 3W; 2700/5500K; OUTPUT: 95-98LM	104			
		Well Light	12V; 6W; 3000K; OUTPUT: 580LM	106			
		Transformers & Accessories	-	100W Transformer	120V; 100W MAX; 12V	108	
300W Transformer	120V; 300W MAX; 12-15V; 13AMP BREAKER ON PRIMARY			110			

# Appendix (Continued)

	Sub-Category	Lighting Solution	Technical Details	Page
Down Lighting	Thin Lines	5CCT LED Thin Line Down Light (Round)	120V AC; 6-20W; 2700/3000/3500/4000/5000K; OUTPUT: 420-1944LM	114
		5CCT LED Thin Line Down Light (Square)	120V AC; 9/12W; 2700/3000/3500/4000/5000K; OUTPUT: 630/840LM	116
	Regressed	Regressed Down Light (CCT)	120V AC; 9-12W; 2700/3000/4000K; OUTPUT: 630-800LM	118
	Gimbal	5CCT LED Gimbal Down Light	120V AC; 8/14/18W; 2700/3000/3500/4000/5000K; OUTPUT: 650/1000/1200LM	120
	Surface Mount / Decorative	Surface Mount Down Lights (Round)	120V AC; 11-22W; 3000/4000K; OUTPUT: 880-1850LM	122
		Surface Mount Down Lights (Square)	120V AC; 11-22W; 3000/4000K; OUTPUT: 880-1850LM	124
		Ceiling Lights	120V AC; 25W; 3000K; OUTPUT: 1875LM	126
		Wall Sconce	120V AC; 15W; 3000K; OUTPUT: 1500LM	128
	T-Edge Lights	T-LED Edge Light (5CCT)	100-277V AC; 20-60W; 3000/3500/4000/5000/6500K; OUTPUT: 2500-5000LM/5000-7500LM	130
	Fire Rated	5CCT Fire Rated Thin Line	120V AC; 12-15W; 2700/3000/3500/4000/5000K; OUTPUT: 800-1100LM	132
Industrial Lighting	-	Tri-Proof Lights	100-277V AC; 40W; 4000K; OUTPUT: 4400LM	134
		100W LED Work Light	100-277V AC; 100W; 5000K; OUTPUT: 12500LM	136
		60W LED Work Light	120V AC; 60W; 5000K; OUTPUT: 7200LM	138
		LED String Work Light	120V AC; 60W; 5000K; OUTPUT: 7500LM	140
Drivers & Controllers	Switchex®			146
	Dimmable Driver/Dimmer Compatibility List			148
	LED Drivers			149
	LED Drivers Selector Chart			150
	LED Controllers List			152
Tokistar	Tokistar Lighting			156
Appendix	-			158
Logos/Icons	-			161

# Featured Logos/Symbols



Intertek's ETL Certified



Energy Star Certified



120 Volts of AC Power



cULus Certified



DLC Certified



CCT



Wet Location Listed



RGB



Dimmable



Wattage Adjustable



## WARRANTY

MAGIC LITE 2013 LTD. warrants this lighting system to be free from defects in material and/or workmanship, under normal use and service, for a period of TWO to SIX YEARS (see specifics on product specifications) from the date of original purchase.

In the event of a defect in material or workmanship during the warranty period, Magic Lite 2013 Ltd. will repair or replace (at its option) your Lighting System under the conditions of warranty. Magic Lite 2013 Ltd. will do this at its expense for the cost of materials but not for shipping. THIS REMEDY IS THE SOLE AND EXCLUSIVE REMEDY FOR ANY AND ALL CLAIMS RELATING TO ANY BREACH OF WARRANTY BY Magic Lite 2013 Ltd.

### LIMITATIONS, EXCLUSIONS AND OTHER RIGHTS

- A. Except as provided herein, Magic Lite 2013 Ltd. makes no other warranties express or implied including but not limited to the implied warranties or merchantability or fitness for a particular purpose, and all such warranties are expressly disclaimed.
- B. In no event shall Magic Lite 2013 Ltd. be liable for indirect, incidental or consequential damages, even if Magic Lite 2013 Ltd. has been advised of the possibility of such damage. This disclaimer applies during and after warranty period.
- C. Magic Lite 2013 Ltd. is not responsible for malfunctions in and/or damage to Lighting Systems where a sale is specifically made without warranty. In such an event the disclaimers of warrant and liability, set forth above, shall continue to apply.
- D. This warranty covers normal consumer use and does not cover damage which occurs during shipment or failure which results from alteration, accident, theft, misuse, abuse, abnormal use, negligent installation, improper maintenance or where adequate care has not been taken to prevent ice or snow damage to the lighting system.
- E. Specifically, when installing mini disc lights in harsh environments such as limestone, salted areas, coastal environments etc. Please use the stainless steel version to avoid the risk of corrosion to body of fixture and voiding warranty.
- F. This warranty gives specific legal rights, and you may also have other rights which vary from province to province.

If you discover a defect or malfunction during the period to which this warranty applies, call or email Magic Lite 2013 Ltd. for information or to receive warranty service.

**Note: You must contact our office for a RETURN GOODS AUTHORIZATION number before returning product. After inspection it will be determined whether a credit is due.**

## ABOUT US

Magic Lite is *your trusted partner* for lighting solutions engineered to brighten spaces and make lives shadow-free. With a dedication to quality and a passion for innovation, we craft environments that inspire.

### Lighting Solutions That Matter —

We take immense pride in delivering top-quality architectural and specialty lighting products, tailored to the Canadian market. From the latest, cutting-edge LED strip lights to timeless classics like puck lights, our range of lighting options caters to your needs. Whether it's task lighting, linear lighting, under cabinet lighting, landscape lighting, or exquisite decorative lighting, we've curated a selection styled to meet your specific requirements.

### Count On Us For Prompt And Reliable Delivery —

We ship daily from our fully-stocked warehouses in Burlington, Ontario and through stocking distributors across Canada – to ensure our products are delivered when and where you need them.

### Exceeding Your Expectations —

Our customers are our driving force. We've earned their trust by consistently delivering innovative solutions that cater to their unique needs, all backed by exceptional service. We'd be thrilled to do the same for you.