

Illuminate your outdoor spaces with brilliance using our In-Ground Well Light, meticulously engineered for outdoor applications.

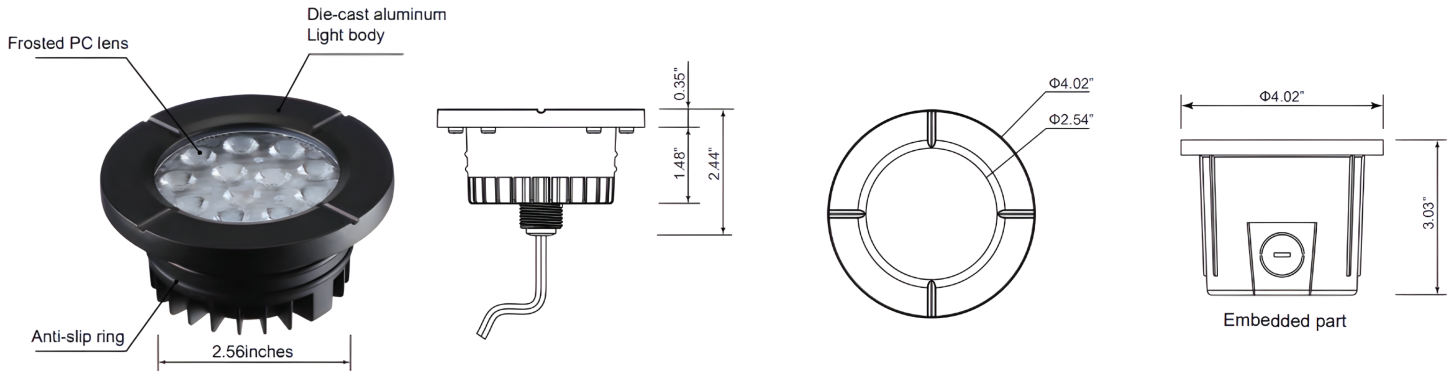

Key Features

- Silicon filled wirenuts
- IP67 rated
- Wet location listed
- Material:
Body: Aluminum | Cable: Copper | Lens: PC
- Weight: 0.87lbs
- Working temperature: -4 °F - 104 °F
- 15 year warranty

Specifications

Color Temperature	3000K
Input Voltage	12/24 AC/DC
Wattage	6W
Lumens	580LM
Beam Angle	52 Degree
LED Type	SMD2835
CRI	>90
Lifespan	50,000 Hours
Limited Warranty	15 years
Approvals	cETLus

Ordering Code(s)

IG-01-12V-36D-BLK

Project		Type	
Date		Contact	
Notes			