

## Features

Dimmable with any standard MLV/Incandescent TRIAC-  
(Leading edge) dimmer switch  
Super compact ALUMINUM CASE.  
Class 2  
UL 8750  
IP67 - Withstands wet and salty conditions.  
Auto-Reset Protection for short circuits, over-voltage  
and over-temperature.  
FCC 15 part 2  
12V DC True RMS

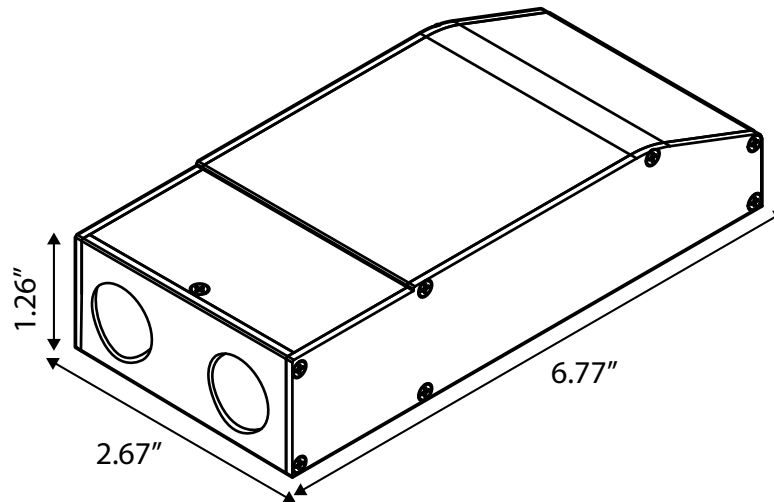

## Specifications

Max Load	20W
Input Voltage	120V AC
Input Current at Max Load	0.2 A
Output Voltage	12V DC
Output Current at Max Load	1.7 A
Power Factor	0.95
Efficiency	> 90%
Operating Temp.	-20°C - 70°C (-4°F - 158°F)
Short circuit protection	Yes
Overcurrent	Yes
Over temperature	Yes
Open circuit protection	Yes
Input Wires (White \ Black)	14 AWG
Output Wires (Red \ Purple)	18 AWG
Dimensions L*W*H	6.77" x 2.67" x 1.26"
Weight	17 oz

## Installation

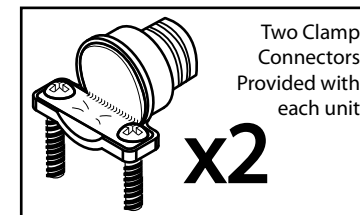
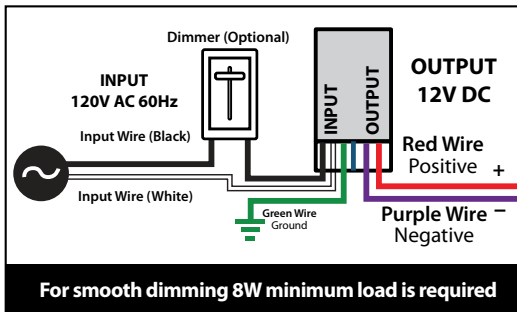

Revisions:

4		
3		
2		
1		



Project:

Part number: MLDRE-20-12-DM

Scale: NTS

Product: ELECTRONIC LED DRIVER 20W 12V DC IP67 DIMMABLE

Type:

Date: