

## ELECTRICAL CONNECTIONS

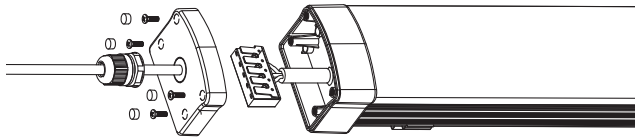

1. Turn power off from electrical panel prior to installation.
2. Un-screw wire strain relief from the end of the fixture.
3. Remove 4 screws that secure the end cap to the fixture.
4. Pull power wire through holding nut and through the center hole in the end cap.
5. Using quick-connect push-in terminals, connect the green ground wire to the green wire terminal; black wire (hot) to black wire terminal; white wire (neutral) to white wire terminal.
6. Replace the end cap with 4 screws and screw covers.
7. Screw in wire strain relief.
8. Test Tri-Proof fixture by turning on the power.

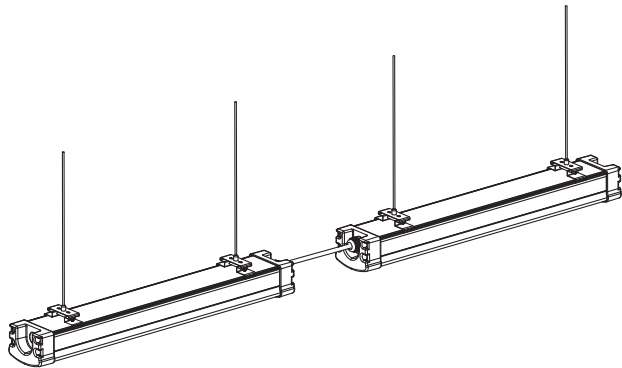

Fixtures can be connected in a continuous line by repeating the steps above on the other end of the fixture using water-resistant SJ00W cable (or equivalent).

## DIRECT CEILING INSTALLATION

1. Drill 6mm hole, insert screw anchors and screw in mounting clips (use either standard clip or optional swivel clips in order to angle the fixture).

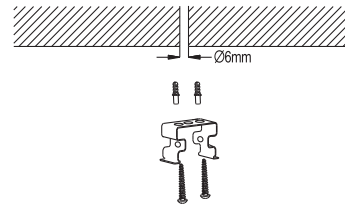

Swivel Mount Kit (PART# SL66-AD-MC - SOLD SEPARATELY)

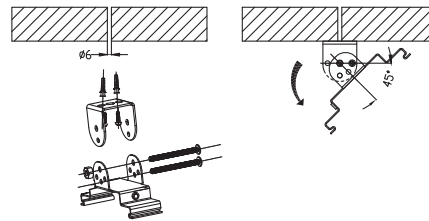

2. Push Tri-Proof fixture into clips by applying even pressure. The clip will snap into the track on the back of the fixture.

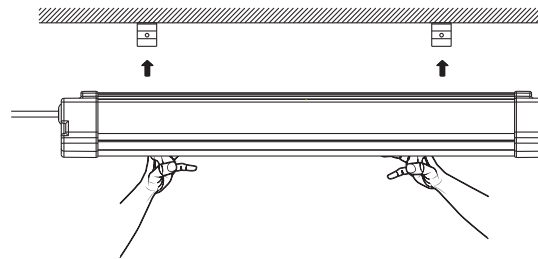

3. Insert and tighten clip side screws to complete installation.

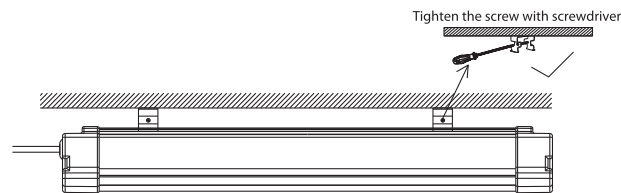

## SUSPENDED CEILING INSTALLATION

Suspension Kit (part# SL-SK) sold separately.

1. Turn power off from electrical panel prior to installation.
2. Drill 6mm hole, insert plastic screw anchors (#9) and screw (#7) in top installation mount (#8)
3. Screw top suspension wire nut (#6), which is attached to suspension wire (#5), into top installation mount (#8)

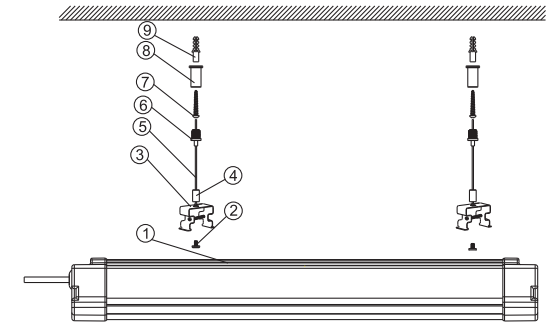

### Parts list

1	LED Tri-proof Light	1 PC
2	Fixture mounting clip screws	2 PCS
3	Fixture mounting clip	2 PCS

### Suspension Kit (PART# SL66-SUS-KIT - SOLD SEPARATELY)

4	Suspension wire base nut	2 PCS
5	Suspension wires	2 PCS
6	Suspension wire top nut	2 PCS
7	Screws	2 PCS
8	Installation mount	2 PCS
9	Plastic anchors	2 PCS

4. Remove bottom screw from Suspension wire base nut (#4) and attach fixture mounting clip (#3) on both cables.
5. Firmly attach fixture mounting clips (#3) and screw in fixture mounting clip screws (#2)
6. Test Tri-Proof fixture by turning on the power.

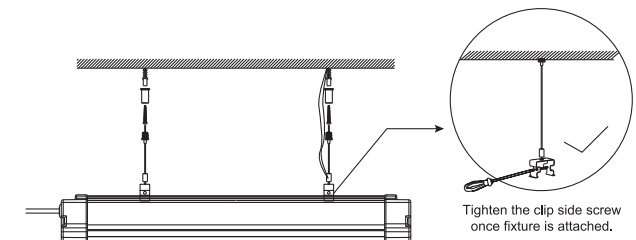

## SPECIFICATIONS

Input Voltage: 100-240V/277V

Luminous Efficacy (LPW): 90–100lm/W

Power Efficiency: Up to 80% energy savings

Colour Temperature: 3000K, 4000K, 5000K, 6500K

Colour Rendering Index: CRI>80

Beam Angle: 120°

Impact Resistant: IK10

Working Voltage: DC34-40V

Watt: 40W

cETLus and DLC listed

Working Life-span: 50,000 hrs

THD: <15%

LEDs: 240

Operating Temperature -30°C – 45°C (-22°F – 113°F)

Excellent heat dissipation

Available in 4 ft. length / 40W version

## CAUTIONS

**CAUTION!** Only qualified electricians, should bring 120VAC power to the fixture. Wiring may require an inspection by the local building department. Check with your local building department before installation.

**CAUTION!** Before bringing 120VAC power to the fixture, make sure incoming wire is not "hot" and all power coming to the wire is off.

**CAUTION!** All connections must be made in accordance with this instructional manual, current Electrical Code, and all local building codes.

- Minimum 75C supply connectors.
- Access above ceiling required.
- Suitable for damp locations.
- Dimmable with standard 0 – 10V dimmers.

## APPLICATIONS

- Parking Garages
- Tunnels
- Airports
- Exhibition halls
- Railway, bus and subway stations
- Warehouses and factories
- Supermarkets
- Schools

## INSTALLATION AND SAFETY INSTRUCTIONS

# Tri-Proof Lights



Tri-Proof Lights are an attractive and durable lighting solution that can replace traditional linear fluorescent luminaires. Tri-Proof Lights are extremely rugged, resistant to heavy impacts, dust proof, water proof and vandal resistant making them ideal for environments such as factories, warehouses, parking garages and car washes yet stylish enough for commercial and residential applications like stairwells, hallways, schools, supermarkets, apartment and condo complexes.

**M** **MAGIC LITE**  
YOUR TRUSTED LIGHTING PARTNER  
[www.magiclite.com](http://www.magiclite.com)

**M** **MAGIC LITE**   
YOUR TRUSTED LIGHTING PARTNER