

LTSPRO-12-YY is constructed with aluminum housing and a matte white polycarbonate diffuser. It has a hi-low rocker switch and a slide selector switch for changing Kelvin colour temperature.

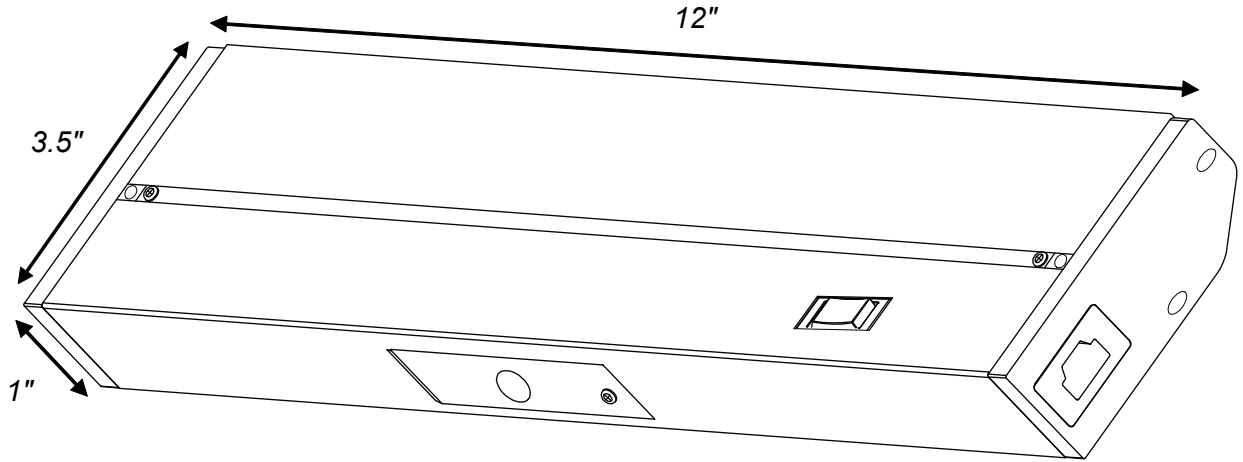

Features

- Adjustable to 3 colour temperatures: 2700K, 3300K and 4000K (warm white to cool white)
- Dimmable with most ELV dimmers
- Comes with High / Low Switch
- Low power consumption
- Edge Lit technology eliminates hot spots - smooth luminance
- Fast and easy installation - quick connects, captive mounting screws
- Comes with cord and plug as well as knockouts for hardwire
- 3/8" connector provided
- Shallow profile conceals fixture
- Linkable up to 400 watts
- 90 CRI - the best in the business!
- Available in 6 sizes 9", 12", 18", 24", 32" and 40"
- 3 year limited warranty
- cETLus and EnergyStar listed for dry locations.

Specifications

Colour Rendering Index	90+
Input Power	120V
Colour Temperature	2700K - 4000K
LEDs	Epistar
Power Factor	0.95
Watt	5W
Lumens	250-300
Dimensions	L - 12" W - 3.5" H - 1"
Dimmable	Yes
Finish Colour	BK - Black BZ - Bronze SN - Satin Nickel WH - White

* Specifications and dimensions subject to change without notice.

Ordering Code:

LTSPRO - 12 -

- Finish Colour: **BK** - Black
BZ - Bronze
SN - Satin Nickel
WH - White

Included with each fixture:

- (1) Under cabinet lighting fixture
- (1) 182.88 cm (72") cord and plug
- (1) End-to-end connector
- (1) Romex connector
- (2) Wood screws
- (1) 20.86cm (8") jumper cable

Project		Type	
Date		Contact	
Notes			