

INSTALLATION GUIDE

For installations with multiple lengths of RGB Neon Flex, you will need an additional signal amplifier and class 2, 24V DC non-dimmable power supply for each additional run, as follows:

A. Linear Installation Layout

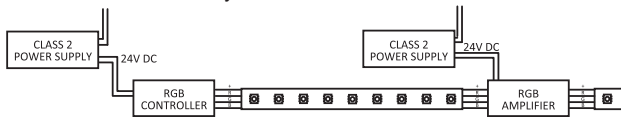

B. Multiple Run Layout

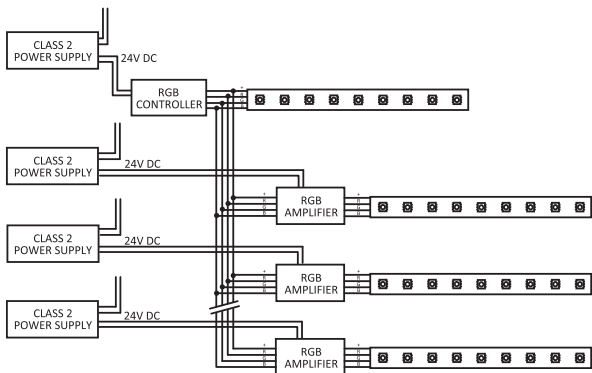

1. Connect wires from output of controller to input side of signal amplifier. If continuing in a straight line, you may simply connect from the end of previous piece of RGB Neon Flex to the input side of the signal amplifier by using an opposite power feed (part# NFLX-RGB-CONKIT-6FT-O). If running wires from the output of the controller, in multiple parallel runs, we recommend using wires of at least 18AWG.

2. Connect next length of RGB Neon Flex to the output side of signal amplifier.

NOTE: Black wire on power feed connectors goes to (+) on both input and output of the signal amplifier.

3. Connect the low voltage side of the class 2 power supply to the +/- contacts of the signal amplifier.

4. Connect line voltage side of the power supply to line voltage.

ACCESSORIES

NFLX-RGB-CONTROL
(RGB controller)

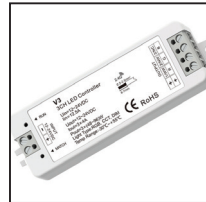

NFLX-RGB-AMP
(RGB signal amplifier)



NFLX-RGB-CONKIT-6FT
(RGB power feed connector,
6FT)

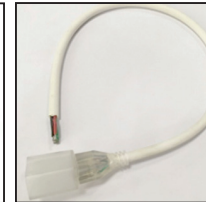

NFLX-RGB-CONKIT-6FT-O
(RGB power feed connector,
6FT, opposite)



NFLX-RGB-JUMP
(RGB Jumper
connector 15cm [6in])

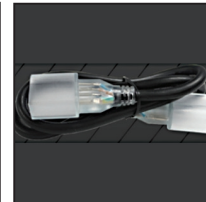

NFLX-RGB-PINS
(RGB pins)

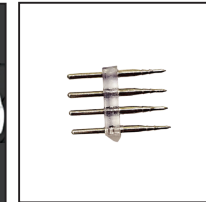

NFLX-ENDS
(End cap)



NFLX-CLIPS
(Mounting clips)

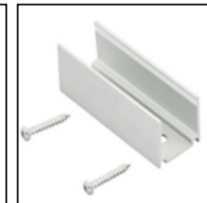

NFLX-CHANNEL
(Aluminum mounting channel 1M [3.28FT])



NON-DIMMABLE POWER SUPPLIES

- **MLDR-120-24**
- Indoor/Outdoor
- Max recommended load:
90W per single tap,
120W combined two secondary taps
- 120W hardwire
- Input: 100-240V AC
- Output: 24V DC
- 10" x 3 3/8" x 3 3/16" (254 x 85.7 x 80.9mm)

INSTALLATION AND
SAFETY INSTRUCTIONS

RGB LED Neon Flex

NFLX-XX-RGB

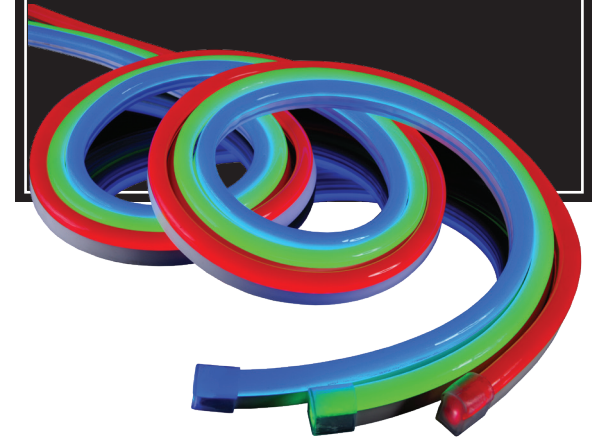

Applications:

- Building outlines
- Stairway and aisle lighting
- Signs
- Decks
- Pathway Lighting
- Billboards
- Highlighting architectural features



2013 LTD.

MAGIC LITE ■
www.magiclite.com

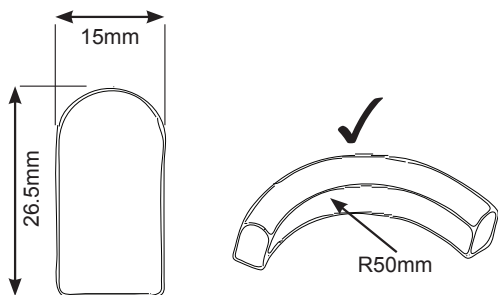

IMPORTANT: Read all instructions in order to ensure safety and proper installation.

⚠ WARNING

DO NOT modify this fixture. Any modifications may render the product unsafe and void warranty.

⚠ WARNING

DO NOT twist, hang vertically, suspend unsupported in the middle or bend along short side.

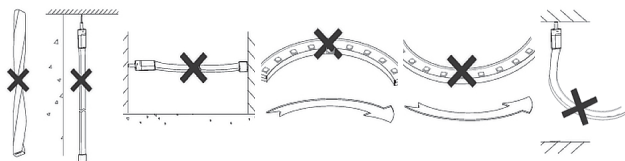

WARNING: Risk of fire and electric shock

1. Do not cover this product as covering may cause cause the flexible light to overheat and melt or ignite.
2. Do not operate the flexible light tightly coiled.
3. Do not route the cord or flexible light through walls, ceiling, doors, windows or any like part of the building structure.
4. Do not submerge flexible light in liquids or use the product in the vicinity of standing water.
5. Do not use if there is any damage to the flexible light or cord insulation.
6. Do not secure the cord or the flexible light with staples, nails or like means that may damage the insulation.
7. Do not install on gates or doors, where subject to flexing.
8. Do not install in cabinets, tanks or enclosures of any kind.

FOR OUTDOOR INSTALLATIONS:

9. Ground Fault Circuit Interrupter (GFCI) protection should be provided on the circuit or outlet.
10. All 120V electrical connections should be carried out by a qualified electrician.
11. Products should be installed in accordance to these instructions, current building codes, current Canadian Electrical Code, or National Electrical Code.

Limited Warranty The warranty applies to the product from the original date of purchase for three (3) years against manufacturing defects. The owner must provide a copy of the original proof of purchase. The manufacturer's obligation under this warranty is limited to repairing or replacing the component. It is not related in any way to the cost of connection, the installation of the replacement parts or cost of transport.

INSTALLATION GUIDE

CONNECTING RGB NEON FLEX TO POWER

RGB Neon Flex runs on 24V DC Class 2 power supply. Use only power supplies from Magic Lite approved for use with Neon Flex. Use only extension cords and power cords provided by Magic Lite. Make sure all the end caps and connections are firmly seated to preclude the entry of water.

A) Cut Neon Flex to desired length at the cutting marks, using a sharp knife or cable cutters.

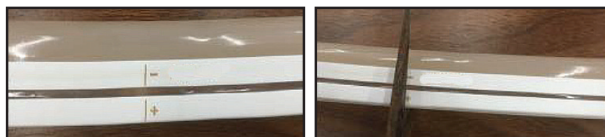

NOTE: RGB Neon Flex is cuttable every 12".
Cutting anywhere else, will damage the product.

B) Holding the smooth side of the power pins with a pair of pliers, line up the barbed side of the pins with the four wires of the flexible light. Push barbed pins into the RGB Neon Flex, making sure to make solid contact with internal wires.

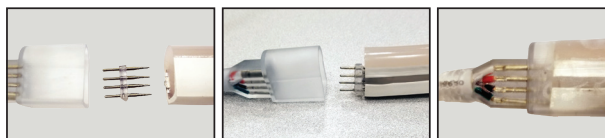

C) Apply silicone glue inside the connector sheath, then push the cord sheath onto the assembly until fully seated. Wipe any excess of glue, using a clean towel.

D) Apply silicone glue inside the end cap.

E) Attach the end cap to cover the dead end of the flexible light. Wipe the excess silicone with a dry towel.

F) Leave the assembly to dry for several hours.



NOTE: 120V connections to power supply should be carried out by a qualified electrician.

INSTALLATION GUIDE

CONTROL OF RGB NEON FLEX

NOTE: As RGB Neon Flex is powered by class 2, 24V DC power supplies, you will need one power supply and one RGB controller for the first 40Ft run of RGB Neon Flex. A signal amplifier and additional class 2 power supply will be required for each additional 40FT (or part of thereof) of RGB Neon Flex.

NOTE: In outdoor applications, power supplies, controllers and signal amplifiers must be placed in weather proof enclosures, or to be outdoor rated.

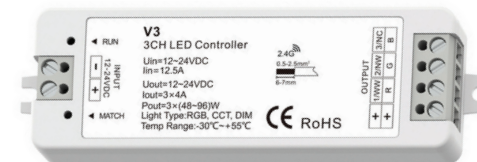

1. Connect power feeds to RGB Neon Flex as per instructions above.
2. Connect the wires from the power feed connector to output side of RGB controller. The output side of the controller is marked (+), R, G, B. Connect black wire to (+), red wire to R, green wire to G, white wire to B on the controller.
3. Connect the input side of the controller to appropriate size of 24V DC power supply.

NOTE: use only non-dimmable class 2 power supplies supplied by Magic Lite, for color changing applications.

4. Connect line voltage of the power supply to line voltage.

NOTE: Line voltage connections should be carried out by a qualified electrician.