



MAGIC LITE LTD.

Product Specifications

MODEL: LV-DMX-IP-RGB-4CH



Summarization

DMX common controller adopts the advanced micro control unit, it receives standard DMX-512 digital control signal and transformed it into PWM signal for driving LED; You could connect DMX module with DMX digital console to achieve dimming or various changes in procedures.

Technical Parameters

- Working temperature: -20-60 °C
- Supply voltage: 24VDC
- Output: 4 channels
- External dimension: L165×W68×H40 (mm)
- Packing size: L180×W95×H60 (mm)
- Net weight: 340g
- Gross weight: 381g
- Static power consumption: <1W
- Output current: each channel 8A
- Output power: 24V:<864W



External Dimension

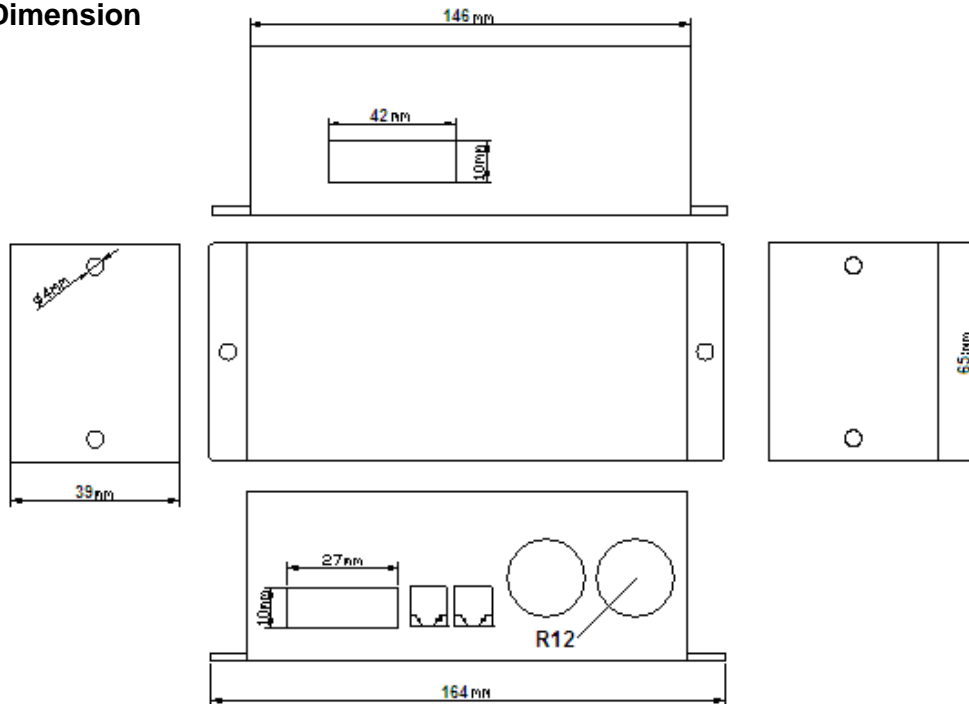

Interface specifications

DMX input/output interface:

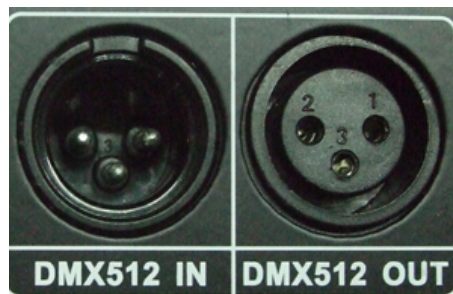

The interface of settings for address code and function:

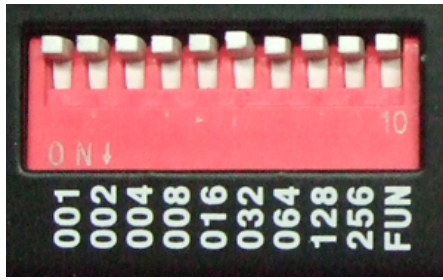

DMX input/output interface: RJ45 Interface



Supply power and load interface:

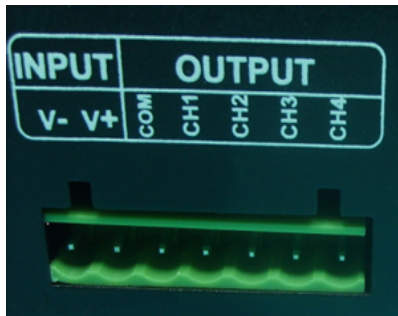

Direction for use

DMX address code settings

Each DMX common controller occupied 3 DMX addresses, adopt coding switch set address, it is a Binary numerical code switch which is setting DMX original address code from 1 to 9, 1 is the lowest, and 9 is the highest, 511 address codes could be setted in all. DMX original address code equal aggregate value of the coding switch value from 1 to 9, dial the coding switch upwards (ON is setted 1), the value of bit can be gotten, on the contrary, the value of bit is 0.

DMX signal can be received when coding switch FUN(10)=OFF (ON is setted 0).

1. example 1:

Look at the following picture, if you want to set 37 as the address code, you can only dial down the first, the third and the sixth code switch, the aggregate value of coding switch value from 1 to 9 is $32+4+1$, that is, the original address code of DMX512 is 37.



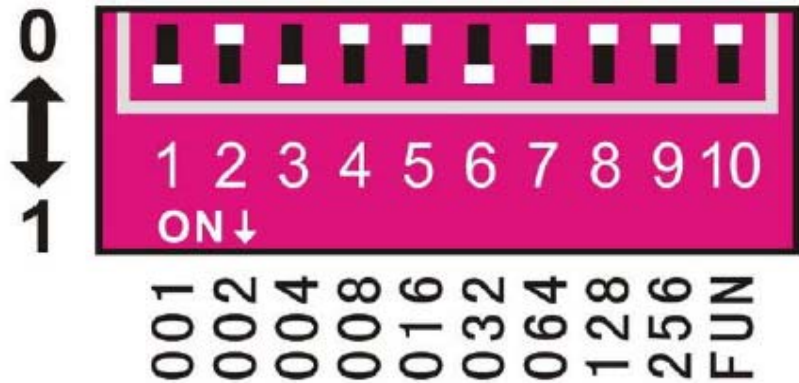

Picture 1

2. example 1:

Look at the following picture,if you want to set 328 as the address code,you can only dial down the ninth,the seventh and the fourth code switch, the aggregate value of coding switch value from 1 to 9 is $256+64+8$,that is,the original address code of DMX512 is 328.

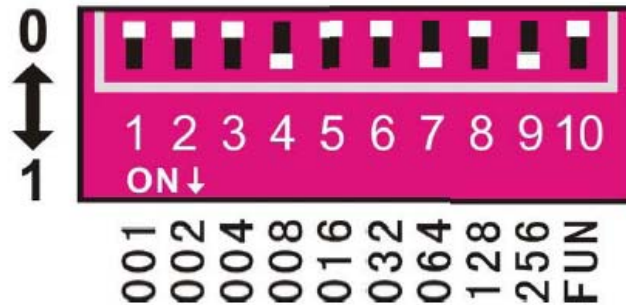

Picture 2

Other functions direction for use

1. Testing function:

The tenth bit of coding switch is "FUN",that is a built-in function button.FUN=OFF shows the DMX decoder function,DMX signal can be received.

The default coding switch1-9 is off:black

Switch1=ON:red

Switch2=ON:green

Switch3=ON:blue

Switch4=ON:yellow

Switch5=ON:purple

Switch6=ON:cyan

Switch7=ON:white

Switch8=ON:seven-color jumpy changing(8 steps speed)

Switch9=ON:seven-color gradual changing(8 steps speed)



MAGIC LITE LTD.

2. The speed choice of jumpy changing, gradual changing effect

When test the function, switch 8=ON shows the seven-color jumpy changing effect, switch 9=ON shows the seven-color gradual changing effect, every effect has 8 steps speed:

Off switch from 1 to 7: 0 steps

Switch1=ON:1 steps

Switch2=ON:2 steps

Switch3=ON:3 steps

Switch4=ON:4 steps

Switch5=ON:5 steps

Switch6=ON:6 steps

Switch7=ON:7 steps(the greatest speed)

There are several switches=ON at the same time, the great value is standard. All dial code switches= ON as the following picture, the state of the decoder shows: to test the functional effects of gradual changing, the speed of change is 7.

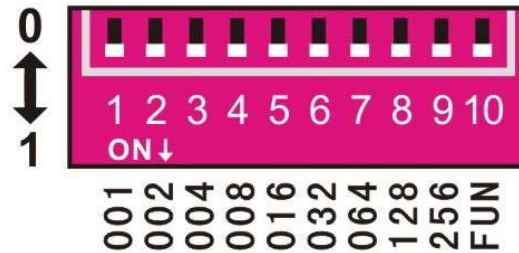

Typical applications

