

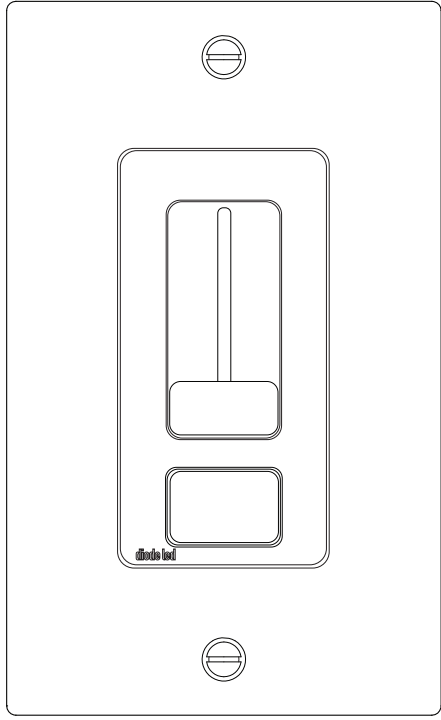

# SWITCHEX<sup>®</sup> Dimmer + Driver

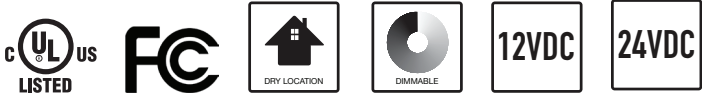

## COLOURS AND FINISHES



# SPECIFICATION SHEET

## OVERVIEW

SWITCHEX simplifies LED array lighting systems by combining an inwall LED dimmer switch and power supply into a single integrated unit. SWITCHEX mounts in a standard in-wall switch box, accepts 120V AC and converts to low voltage DC. SWITCHEX is compatible with 2-channel 12V and 24VDC tape lights and fixtures.

## FEATURES & BENEFITS

- First LED Driver + In-Wall Dimmer Switch in one unit.
- Simplifies LED installation by eliminating compatibility issues between driver and dimmer.
- Fits in a standard recessed electrical box.
- 100% - 1% smooth dimming.
- No minimum load.
- Single Pole preset dimmer with on/off push switch.
- Adjustable voltage output dial to address voltage drop.
- Includes voltage barrier partition to install high and low voltage circuit in same switch box.
- No derating required when ganging units.
- Power failure memory: If power is interrupted, SWITCHEX will return to setting prior to interruption.
- 3x included face plates: Glossy White, Glossy Light Almond, and Glossy Dark Brown (trim plates not included).

## APPROVED 24V LED FIXTURES

- LED HP Strip Series**
- LED eSTRIP**
- LED Globe Light**
- LED Hard Strip**
- LED Thin Star**
- LED Mini Star II**
- LED Britestrip**

## APPROVED 12V LED FIXTURES

### LED Disc Light

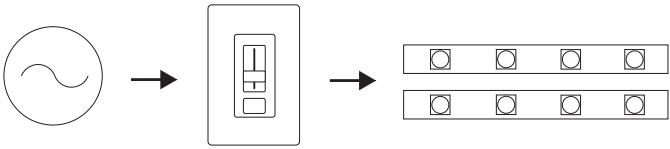

Item #	
Project	

## SPECIFICATIONS

### Compliance & Regulatory Approvals

- cULus Listed (US & Canada) Low Voltage Lighting System #E472619.
- FCC Approved. Complies with the limits for a Class B digital device, pursuant to Part 15 of the FCC Rules.
- RoHS Certified.
- CE Certified.
- Conforms to NEC Code 725.136 (See Mechanical Diagram): Class 1 and Class 2 circuit in same enclosure must be separated by a barrier (partition) unless Class 2 circuit conductors are installed in accordance with 725.41 Class 1 Circuits.

### Input

- Input Voltage: 120VAC (108 ~ 132VAC), 50/60Hz (47 ~ 63Hz)
- Power Factor: >0.9 @ 120VAC 60Hz max load.
- Total Harmonic Distortion (THD): ≤20% @ 120VAC 60Hz max load. Tested to comply in accordance with IEC 61000-3-2.
- Stand-by Power: ≤0.5W.
- Efficiency: ≥91% @ 120VAC max load.
- Input Current: <1.0A @ 120VAC max load.
- In-Rush Current: Meets NEMA-410 requirement at any nominal input full sine wave voltage and maximum load at 25°C.
- Leakage Current: <500µA @ 120VAC.
- Surge/Transient: Tested to meet transients defined in IEC 6100-4-4, level 3 & IEC 6100-4-5, level 3.

### Output

- Dimming: Output voltage is adjustable via sliding lever
- Voltage Adjustment Dial: Increases output +1V to compensate for voltage drop from control to luminaire.
- Startup Time: The main supply output voltages remain within the regulation limit of +/- 3%.
- Protections: Short circuit, thermal runaway, and over voltage.
- Output Ripple Current: ≤20% of the rated output current @ 120VAC max load.

### Environmental Requirements

- Indoor use only.
- Ambient Operating Temperature: 0°C to 40°C
- Humidity: 8 ~ 90% relative humidity, non-condensing.

### SYSTEM DIAGRAM

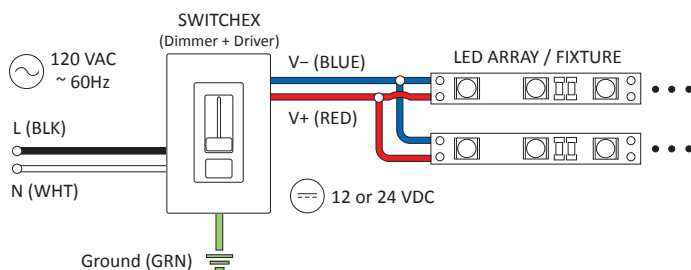

## DIMMER MODELS

	Input	Output	Max Load
SX-12V-DD-60W	120VAC	12 VDC	60 W, 5A
SX-24V-DD-100W		24 VDC	100 W, 4.2A

† Each Item # includes following accessories:

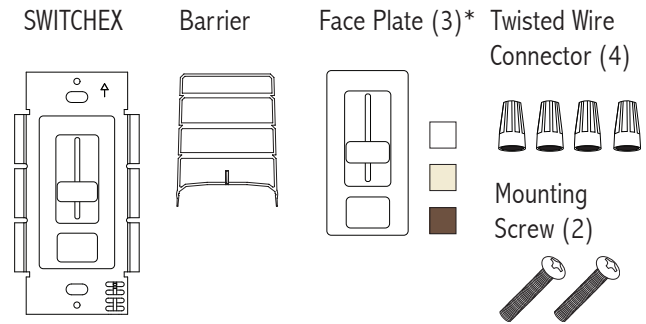

\* Face Plates are interchangeable:

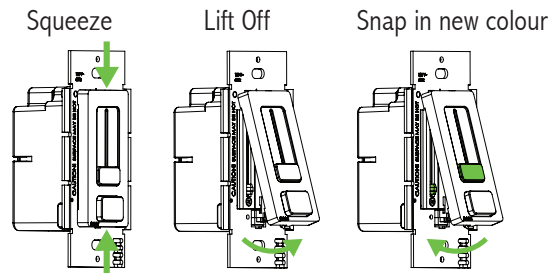

### TRIM PLATES (SOLD SEPARATELY)

ITEM #	COLOUR/FINISH	
SX-TP-WH	Glossy White	
SX-TP-LA	Glossy Light Almond	
SX-TP-BR	Glossy Dark Brown	

### TRIM PLATES (SOLD SEPARATELY)

ITEM #	COLOUR/FINISH	
SX-TP-BL	Glossy Black Includes Black Switchex Face Plate & Trim Plate.	

## OPERATION

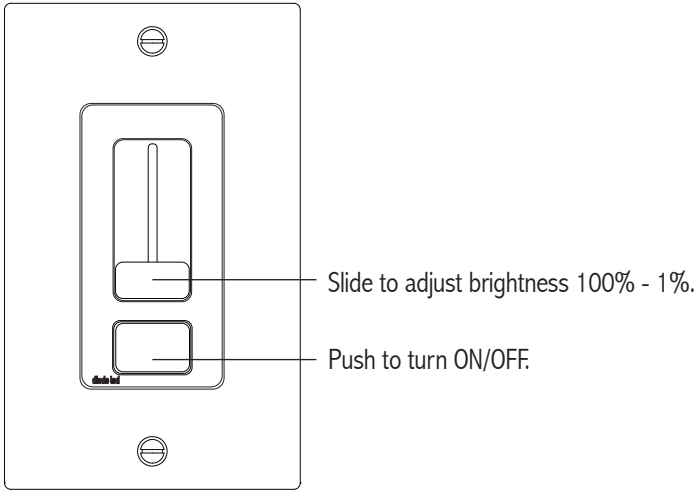

## MOUNTING

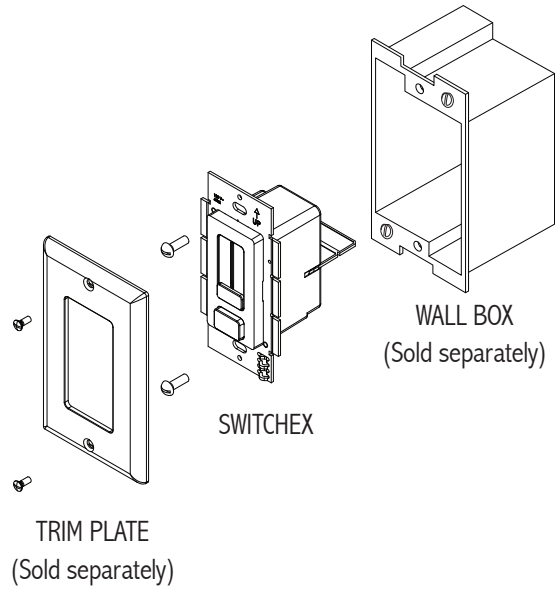

## MECHANICAL DIAGRAM

### SWITCHEX Front

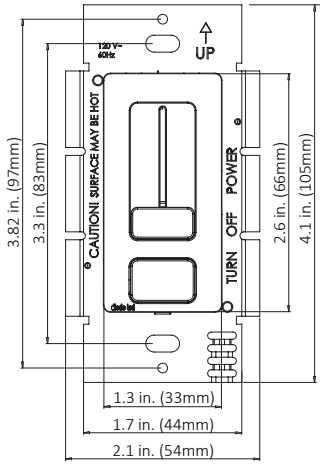

### Back

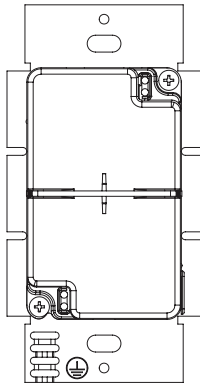

### Side with Voltage Barrier

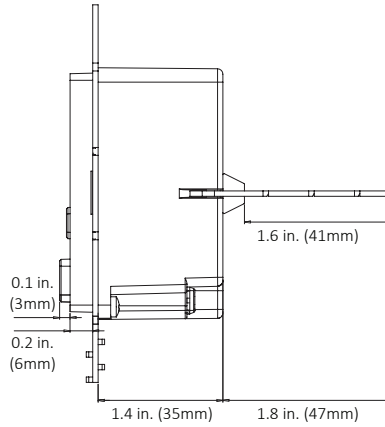

### Trim Plate Front

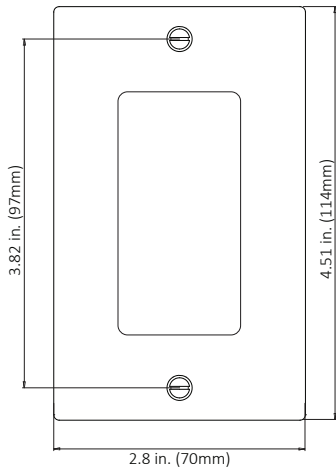

### Side

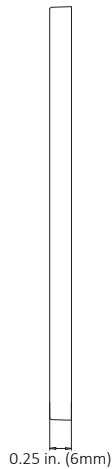

### Barrier Top

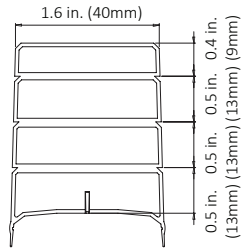

### Side

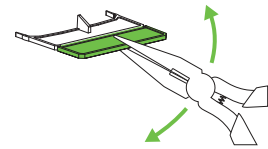
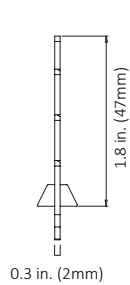

For shallow boxes, barrier can be shortened. Grip with pliers. Bend back and forth until fin breaks off.

## VOLTAGE DROP CHARTS

For best performance and lumen output, ensure proper wire gauge is installed to compensate for voltage drop of low voltage circuits.

### Example: 12V Voltage Drop & Wire Length Distance Chart

Wire Gauge	10 W .83 A	20 W 1.7 A	30 W 2.5 A	40 W 3.3 A	50 W 2.1 A	60 W 4.2 A
18 AWG	34 ft.	17 ft.	11 ft.	8 ft.	6 ft.	5 ft.
16 AWG	54 ft.	27 ft.	18 ft.	13 ft.	10 ft.	9 ft.
14 AWG	86 ft.	43 ft.	29 ft.	21 ft.	17 ft.	14 ft.
12 AWG	134 ft.	68 ft.	45 ft.	34 ft.	27 ft.	22 ft.
10 AWG	199 ft.	99 ft.	66 ft.	49 ft.	39 ft.	33 ft.

① Determine load size. Let's assume load is 55 W. Round up to nearest load.

② Determine distance from SWITCHEX to load. Let's assume the distance is 20 ft.

③ It's recommended to install 12 AWG to eliminate excess voltage drop.

### 12V Voltage Drop & Wire Length Distance Chart

Wire Gauge	10 W .83 A	20 W 1.7 A	30 W 2.5 A	40 W 3.3 A	50 W 2.1 A	60 W 4.2 A
18 AWG	34 ft.	17 ft.	11 ft.	8 ft.	6 ft.	5 ft.
16 AWG	54 ft.	27 ft.	18 ft.	13 ft.	10 ft.	9 ft.
14 AWG	86 ft.	43 ft.	29 ft.	21 ft.	17 ft.	14 ft.
12 AWG	134 ft.	68 ft.	45 ft.	34 ft.	27 ft.	22 ft.
10 AWG	199 ft.	99 ft.	66 ft.	49 ft.	39 ft.	33 ft.

### 24V Voltage Drop & Wire Length Distance Chart

Wire Gauge	10 W .42 A	20 W .83 A	30 W 1.3 A	40 W 1.7 A	50 W 2.1 A	60 W 2.5 A	70 W 2.9 A	80 W 3.3 A	100 W 4.2 A
18 AWG	134 ft.	68 ft.	45 ft.	33 ft.	27 ft.	22 ft.	19 ft.	17 ft.	14 ft.
16 AWG	215 ft.	109 ft.	72 ft.	54 ft.	43 ft.	36 ft.	31 ft.	27 ft.	22 ft.
14 AWG	345 ft.	174 ft.	115 ft.	86 ft.	69 ft.	57 ft.	49 ft.	43 ft.	36 ft.
12 AWG	539 ft.	272 ft.	181 ft.	135 ft.	108 ft.	90 ft.	77 ft.	68 ft.	56 ft.
10 AWG	784 ft.	397 ft.	263 ft.	197 ft.	158 ft.	131 ft.	112 ft.	98 ft.	82 ft.

## VOLTAGE ADJUSTMENT

SWITCHEX can provide a 1V boost if the fixture is receiving noticeable light degradation.

- Pop off face plate as shown in Step 4 of INSTALLATION.
- Use a small screwdriver to adjust output voltage by turning adjustment dial clockwise.

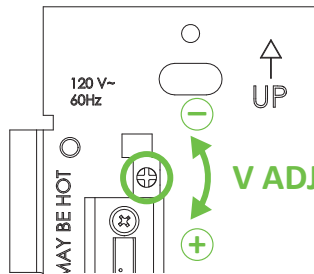

## SAFETY & WARNINGS

1. UNLIKE TRADITIONAL DIMMING CONTROLS, SWITCHEX REQUIRES UNIQUE WIRING STEPS. READ ALL WARNINGS AND INSTALLATION INSTRUCTIONS THOROUGHLY.
2. Install in accordance with national and local electrical code regulations.
3. This product is intended to be installed and serviced by a qualified, licensed electrician.
4. CEC Code: Rule 16-212 requires the separation of Class 2 conductors from various other circuits like electric power, Class 1, and electric lighting through appropriate minimum separations or barriers of raceway, cable or other metal or non-metal material.
5. Only install compatible 12V or 24V Constant Voltage DC fixtures or warranty will be void.
6. Do not modify product beyond instructions or warranty will be void.

## WARRANTY

### Limited Warranty

This product has a five (5) year limited warranty from the date of shipment. This warranty does not include the additional accessories referenced in this specification sheet. Complete warranty details for fixtures and additional accessories are available at [www.magiclite.com](http://www.magiclite.com) under the 'Tools & Resources' tab. For warranty related questions, please contact product support.

### Consumer's Acknowledgment

Magic Lite stands behind its products when they are used properly and according to our specifications. By purchasing our products, the purchaser agrees and acknowledges that lighting design, configuration and installation is a complex process, wherein seemingly minor factors or changes in layout and infield adjustments can have a significant impact on an entire system. Choosing the correct components is essential. Magic Lite is able to work with the original purchaser to make an appropriate product selection to the extent of the limited information that the customer can provide, but it is virtually impossible for Magic Lite to design a system that foresees every unknown factor. For this reason, this Warranty does not cover problems caused by improper design, configuration or installation issues. Any statement from a Magic Lite employee or agent regarding a customer's bill of goods and/or purchase order is NOT an acknowledgment that the products purchased are designed and configured correctly. The purchase agrees and acknowledges that it is the customer's responsibility to adhere strictly to all information contained in the Product Specification Sheets.

**There is often more than one way to design, configure and layout an LED lighting application properly to achieve the same lighting effect. Magic Lite strongly recommends that licensed professionals be used in the design and installation of lighting systems that include Magic Lite products. The specifications include important information that a designer and installer should carefully review and strictly follow. Qualified designers and certified and/or licensed installers, with access to the final installation environment, customer goals, and Magic Lite product specifications can make the requisite decisions appropriate for a successful finished lighting application.**

